



VB3/VB5/V5 frequency inverter

User manual

Xinje Electronic Co.,Ltd.

No. INV C 01 20081130 204



VB3/VB5/V5
Series Inverter
User Manual

Table of Contents

Preface

Safety Precautions

Product Introductions

Installation and Wiring

Operation Descriptions

Function Parameters

Fault Diagnosis and Disposal

Maintenance

Communication Protocol

This manual includes the basic caution items that you should obey to ensure your personal safety, as well as to protect the product and the connected equipments. These items are highlighted in the manual by a warning triangle. Please comply with the essential electric operation `rules that are not indicated in this manual.

Installing Precautions



Please comply with these items, incorrect operation may cause the system error working even abnormal.
More serious would cause possession loss.

Correct Applications



The device and its components can only be used in the applications described in the catalog and the technical manuals, can only be connected with devices or components from other manufacturers which have been approved or recommended by Xinje.

The products will run normally in the condition of been transported, stored, configured and installed correctly, been operated and maintained as recommended.

Xinje Electronic Co., Ltd. Copyright reserved

Without written authority, please do not copy, transfer or use this document and its content. Anyone who disobeys this should take responsibility for the loss.

Obligation Declare

We have checked and confirmed that the contents in this manual were compatible with the hardware and software described. Since mistakes are hard to avoid, we cannot promise total accordant. This manual is subject to change without notices.

CATALOG

PREFACE	1
SAFETY PRECAUTIONS	2
1 PRODUCT INSTRUCTION	6
1-1. Product overview	6
1-2. Product technical specification	7
1-3. Product appearance	10
1-4. Product dimension	12
2 INSTALLATION AND WIRING	15
2-1. Installation environment	15
2-1-1. Environment requirement	15
2-1-2. Mounting location and space	15
2-1-3. Mounting and removing	15
2-2. Wiring	16
2-3. Wiring of main circuit terminals	16
2-3-1. Wiring diagram	16
2-3-2. Terminal assignment and description	16
2-4. Basic running wiring	18
2-5. Setting and wiring of control circuit	18
2-5-1. Position and function of terminals and jumpers on control panel	18
2-5-2. Terminals on control panel	20
2-5-3. Analog I/O terminal wiring	22
2-5-4. Connection of communication terminals	23
2-6. Mounting guide according with EMC	24
2-6-1. Control the noise	24
2-6-2. Local wiring and grounding	25
3 OPERATING INSTRUCTIONS	26
3-1. Run the inverter	26
3-1-1. Command channel of inverter	26
3-1-2. Frequency setting channel	26
3-1-3. Running state	26
3-1-4. Running modes	27
3-2. Use the keyboard	28

3-2-1. Keyboard layout	28
3-2-2. Keyboard function.....	28
3-2-3. Function description of LED and indicator	29
3-2-4. Display of the operation panel.....	29
3-2-5. Panel operation method	31
3-3. Power on the inverter	33
3-3-1. Checking after power on.....	33
3-3-2. Power on the inverter for the first time.....	33
4 FUNCTION PARAMETERS.....	35
4-1. Function code.....	35
4-2. Function code description.....	51
4-2-1. Basic operating function parameters (Group P0)	51
4-2-2. Parameters of frequency setting (Group P1)	56
4-2-3. Starting and braking parameters (Group P2).....	57
4-2-4. Auxiliary running parameters (Group P3).....	59
4-2-5. Function parameters of terminal (Group P4).....	64
4-2-6. Protection function parameters (Group P5).....	73
4-2-7. Fault recording parameters (Group P6)	75
4-2-8. Close-loop control parameters (Group P7)	75
4-2-9. Simple PLC operation parameters (Group P8).....	78
4-2-10. Swing frequency function parameters (Group P9)	81
4-2-11. Vector control parameters (Group PA).....	83
4-2-12. Special application function parameters (Group PB).....	84
4-2-13. Default setting and password (Group PF).....	85
5 FAULT DIAGNOSIS AND SOLUTION.....	86
5-1. Fault diagnosis and solution	86
5-2. Check the fault records.....	88
5-3. Fault reset	88
6 MAINTENANCE	89
6-1. Maintenance	89
6-1-1. Routine maintenance	89
6-2. Periodical care and maintenance.....	89
6-2-1. Periodical care.....	89
6-2-2. Periodical maintenance	89
6-3. Warranty of the inverter.....	90
7 COMMUNICATION PROTOCOL.....	91
7-1. Overview of communication protocol.....	91

7-2. Communication protocol	91
7-2-1. Communication networking mode	91
7-2-2. Communication protocol modes	92
7-2-3. Communication port	92
7-3. Modbus-RTU communication protocol	92
7-3-1. Character structure	92
7-3-2. Communication information	92
7-3-3. Communication parameter	95
APPENDIX A ACCESSORIES	97
A-1. Brake resistor	97
A-2. Operate panel	98
A-3. Extension cable of operate panel	98
APPENDIX B FUNCTION CONFIGURATION LIST	99

Preface

——Essential introduction for this manual

Thank you for purchasing Xinje inverter, this manual should be read and understood before attempting relevant operations.

1. Purpose of this manual

This manual offers guidance and introductions about how to use and maintains the inverter correctly, including functions, usages, installation, maintenance, etc.

2. Qualified personnel

This manual is intent for the following personnel:

- Inverter installation personnel
- Project technical personnel(electric engineer, electrician)
- Design personnel

The above personnel should read and understand this manual carefully before operating and debugging.

3. Validity of this manual

This manual may only be used for inverters made by Xinje.

4. Electronic Documents

In addition to our written manuals, we offer electronic documentations of our products by the following ways.

- User CD

There are software, user manual and application tip of relevant products.

- Website

Please visit www.xinje.com to obtain all variable electronic documents.

Safety Precautions

Upon unpacking, please confirm that: Check whether the model and the rated values on the nameplate of the inverter are in accordance with your order. Check if there is any damage occurred during transportation; please contact us or the distributor if you find any missing or damage of the products.

In order to use this product correctly, the user who uses the product for the first time must read this manual carefully and pay close attention to the safety precautions.

Please keep this manual properly, hand it to the terminal user and lay it on the place where the operators can read it easily.

☉ Safety Precautions ☉

Confirmations Upon Delivery



Notice

1. Never install an inverter that is damaged or missing components. Doing so can result in injury.

● Installation



Notice

1. Always hold the bottom of the inverter when carrying it. If the inverter is held by the front cover, the main body of the inverter may fall, possibly resulting in injury.
2. Attach the inverter to metal or other noncombustible materials. Fire can result if the inverter is attached to a combustible material.
3. Install a cooling fan or other cooling device when installing more than one inverter in the same enclosure so that the temperature of the air entering the inverters is below 45°C. Overheating can result in fires or other accidents.

● Wiring



Danger

1. Always turn off the input power supply before wiring. Otherwise, an electric shock or fire may occur.
2. Wiring must be operated by an authorized person qualified in electrical work. Otherwise, an electric shock or fire may occur.
3. Make sure to ground the ground terminals. Otherwise, an electric shock or fire may occur.
4. Always check the operation of any emergency stop circuits after they are wired. Otherwise, possibly result in injury (user responsibility for the wiring).
5. Never touch the output terminal directly by your hands or let the output terminals to come into contact with the inverter case. Never short the output terminals. Otherwise, an electric short or ground short may occur.
6. Never touch the internal circuit or the zero-component until power off and the charge indicator is off as there may still be high voltage inside the AC motor driver.



Notice

1. Confirm that the voltage of the main AC power supply satisfies the rated voltage of the Inverter. Injury and fire may occur if the voltage is not right.
2. Do not perform voltage withstand tests on the Inverter. Otherwise, semiconductor elements and other devices can be damaged.
3. Connect braking resistors, Braking Resistor Units, and Braking Units as shown in the I/O wiring examples. Otherwise, a fire may occur.
4. Tighten all terminal screws to the specified tightening torque. Otherwise, a fire may occur.
5. Do not connect AC power to output terminals U, V, and W.
The interior parts of the Inverter will be damaged if voltage is applied to the output terminals.
6. Do not connect phase-advancing capacitors or LC/RC noise filters to the output circuits. The Inverter may be damaged or internal parts burnt if these devices are connected.
7. Do not connect electromagnetism switch, electromagnetism contactor to output circuit. When the inverter is running with load, the electromagnetism switch and electromagnetism contactor will generate inrush current which will cause inverter's over current protection.
8. Do not disassemble the whole front cover as disassembling the top front while wiring is ok. Otherwise, inverter internal parts may be damaged.

● Maintenance and Inspection



Danger

1. Do not touch the inverter terminals, as they may carry high voltage.
Otherwise, an electric short may occur.
2. Make sure to have protective cover. Always have the protective cover in place when power is being supplied to the Inverter. When attaching the cover, please with the power turns off.
Otherwise, an electric short may occur.
3. Maintenance, inspection, must be performed only by authorized personnel.
Otherwise, an electric short may occur.



Notice

1. A CMOS IC is used in the control board. Handle the control board and CMOS IC carefully. The CMOS IC can be destroyed by static electricity if touched directly.
2. Do not change the wiring, or remove connectors or the Digital Operator, during operation.
Otherwise, The devices may be damaged.

◎ Usage Precautions ◎

➤ Constant torque low speed running

When the inverter outputs to a common motor at low speed for a long term, the output rated torque should be derated due to the worsening radiating effect. If low speed constant torque long term running is required, then a special variable frequency motor is needed.

➤ Motor insulation

When using the V5/F5 series inverter, make sure to confirm the insulation of the motor which will be used to avoid device damage. Besides, do the periodic check for the insulation condition of the motor located in the bad environment to guarantee the system can operate safely.

➤ Negative torque load

If in the case of improving load, negative torque may occur. Braking units should be connected with the inverter, or over current and over voltage fault may happen.

➤ **Mechanical resonance point of load**

The inverter may encounter the mechanical resonance point of load within certain output frequency range. Jump frequencies have to be set to avoid it.

➤ **Capacitor and resistor**

Because the inverter output pulse wave, capacitor and resistors shouldn't be connected with the output terminals of the inverter, or the inverter may trip or components may be damaged; Besides, don't connect switch components such as air switch and contactor with the output terminals is recommended, as shown in Fig.0-1(If switch components need to be connected with the output terminals, make sure output current of the inverter is zero when switch is acting).

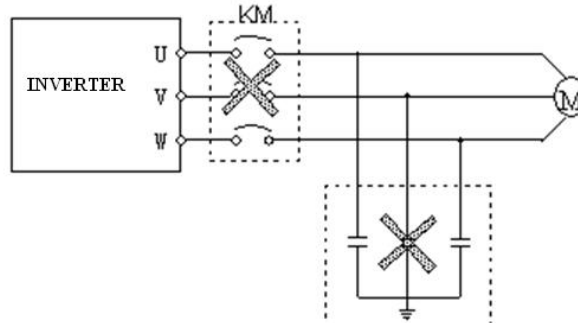

Fig.0-1 Capacitor is prohibited to be connected with output terminals of inverter

➤ **Derate according to basic frequency setting**

When the basic frequency is lower than the reference frequency, please consider duration for the motor so as to avoid motor's damage caused by overheating.

➤ **Running at frequency above 50Hz**

If running at frequency above 50Hz, besides the increment of vibration and noise, the ranges of running speed of motor shaft and mechanical device have to be guaranteed. Be sure to make an enquiry first.

➤ **The electro-thermal protective value of motor**

If the applicable motor is selected as per requirements, the inverter can perform the thermal protection to the motor. If the ratings of applied motor are not in compliance with the inverter, be sure to adjust the protective value or adopt other protective measures to guarantee the safe running of motor.

➤ **Altitude and derate**

When the altitude is higher than 1000m, the cooling effect of inverter is deteriorated because of the rareness of air, deration must be considered, shown in Fig.0-2 which indicates the relationship between the altitude and rated current of frequency inverter.

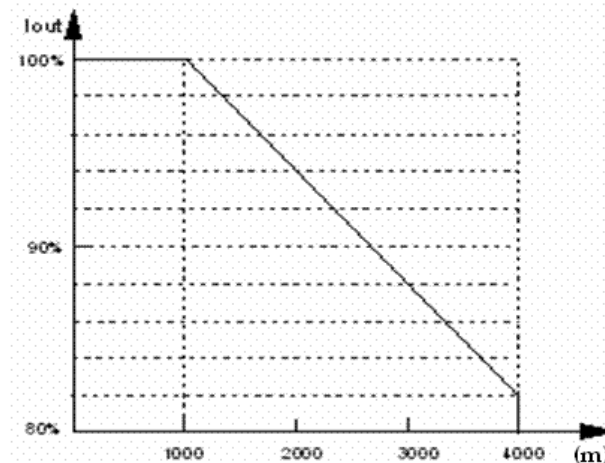

Fig. 0-2 The relationship between the altitude and rated current of frequency inverter

➤ **About protection classes**

The protection class of V5/F5 series inverter IP20 is reached in the case of status display unit or keyboard.

© Note For Scrap ©

When you scrap the inverter, please pay attention to:

Explosion risk of capacitor: The capacitors in the main circuits may explode when they are burned.

Waste gas when plastic parts are burned: Poisonous gas may be generated when front panel is burned.

Dispose method: Please dispose as industrial rubbish.

1 Product Instruction

1-1. Product overview

VB3/VB5/V5 series inverter is produced by Xinje Co., Ltd with high performance, easy operating and low noise. It is a innovative product with a series advanced and practical running and control functions such as practical PI, flexible input and output terminals, parameter modification online, fixed length control, traverse operation, RS485 control, bus-mastering. It provides OEM customers with high integrated, reliable, cost-effective solution.

Name Designation Rules

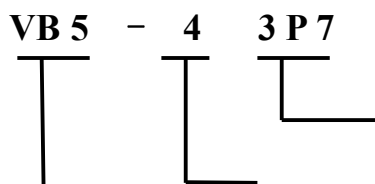

Inverter Series

V5: VVVF/vector control

VB5: VVVF/vector control

VB3: VVVF control, mini type

Voltage Level

2: 220V

4: 380V

Max Suitable Motor's Capacity

011: 11KW

1P5: 1.5KW

And so on

(P: Stands for radix Point)

V5 only has 380V level types; VB3/VB5 series frequency inverter has 220V and 380V voltage levels. Suitable motor capability is from 0.4KW to 55KW.

Please note 220V level types have no vector control.

Type

Voltage level	Type	Rated capacity (kVA)	Rated output current (A)	Match motor (kW)
220V Single-phase	VB3-20P7	1.5	4.7	0.75
	VB5-20P7	1.5	4.7	0.75
	VB5-21P5	2.8	7.5	1.5
	VB5-22P2	4.5	10.0	2.2
380V 3-phase	VB3-40P7	2.1	2.5	0.75
	VB3-41P5	2.5	4.0	1.5
	VB3-42P2	3.0	6.0	2.2
	VB3-43P7	5.9	9.6	3.7
	VB5-40P7	2.1	2.5	0.75
	VB5-41P5	2.5	4.5	1.5
	VB5-42P2	3.0	6.0	2.2
	VB5-43P7	5.9	9.6	3.7
	VB5-45P5	8.5	14.0	5.5
	VB5-47P5	11	17.0	7.5
	V5-4011	15	25	11
	V5-4015	20	33	15
	V5-4018	25	38	18.5
V5-4022	30	46	22	

	V5-4030	40	60	30
	V5-4037	50	75	37
	V5-4045	60	90	45
	V5-4055	75	110	55

1-2. Product technical specification

1. Technical specification

220V

Type		VB3-20P4	VB3-20P7	VB5-20P7	VB5-21P5	VB5-22P2
Output	Match Motor (kW)	0.4	0.75	0.75	1.5	2.2
	Output Current (A)	3.0	4.7	4.7	7.5	10.0
	Voltage (V)	AC 200				
	Frequency Range (Hz)	0~500				
	Frequency Resolution (Hz)	0.01				
	Overload Ability	150%Rated Current for 1 minutes, 180% Rated Current for 1 second				
Input	Rated Voltage/Frequency	Single-phase 220V,50/60Hz				
	AC voltage permit fluctuate range	Voltage: -20% ~ +20% Voltage Unbalance Rate: < 3%				
	Frequency fluctuate Range	Frequency: ±5%				
	Power Capacity (kVA)	0.9	1.5	1.5	2.8	4.5

380V

VB3-4_ _ _		0P7	1P5	2P2	3P7
output	Suitable motor (kW)	0.75	1.5	2.2	3.7
	Rated current (A)	2.5	4.0	6.0	9.6
	Rated voltage (V)	AC 380			
	frequency range (Hz)	0~500			
	frequency accuracy (Hz)	0.01			
	Overload Ability	150% Rated Current for 1 minute, 180% Rated Current for 1 second			
Input	Rated voltage /Frequency	Three phase 380V; 50Hz/60Hz			
	AC voltage fluctuate range	Voltage: -20% ~ +20% Voltage Unbalance Rate: <3%			
	Frequency fluctuate range	Frequency: ±5%			
	Power Capacity (kVA)	2.1	2.5	3.0	5.9

VB5-4_ _ _		0P7	1P5	2P2	3P7	5P5	7P5
output	Suitable motor (kW)	0.75	1.5	2.2	3.7	5.5	7.5
	Rated current (A)	2.5	4.0	6.0	9.6	14.0	17.0
	Rated voltage (V)	AC 380					
	frequency range (Hz)	0~500					
	frequency accuracy (Hz)	0.01					
	Overload Ability	150% Rated Current for 1 minute, 180% Rated Current for 1 second					
Input	Rated voltage /Frequency	Three phase 380V; 50Hz/60Hz					

	AC voltage fluctuate range	Voltage: -20% ~ +20%					
		Voltage Unbalance Rate: <3%					
	Frequency fluctuate range	Frequency: ±5%					
	Power Capacity (kVA)	2.1	2.5	3.0	5.9	8.5	11

V5-4		011	015	018	022	030	037	045	055
output	Suitable motor (kW)	11	15	18.5	22	30	37	45	55
	Rated current (A)	25	33	38	46	60	75	90	110
	Rated voltage (V)	AC 380							
	frequency range (Hz)	0~500							
	frequency accuracy (Hz)	0.01							
	Overload Ability	150% Rated Current for 1 minute, 180% Rated Current for 1 second							
Input	Rated voltage /Frequency	Three phase 380V; 50Hz/60Hz							
	AC voltage fluctuate range	Voltage: -20% ~ +20%							
		Voltage Unbalance Rate: <3%							
	Frequency fluctuate range	Frequency: ±5%							
	Power Capacity (kVA)	15	20	25	30	40	50	60	75

Common characteristics

Environment	Application environment	In-door, free from direct sunlight, dust, corrosive gas, oil mist, steam, water drop etc
	Elevation	Lower than 1000m (The inverter should be derated when the elevation is higher than 1000m)
	Ambient Temperature	-10°C ~ +40°C
	Humidity	Less than 90% RH, No condensation
	Vibration	Less than 5.9 m/s ² (0.6M)
	Storage Temperature	-20°C ~ +60°C
Structure	Protect Configuration	IP20 (In the state of state display units or keyboard)
	Cooling Manner	Fan cooling
Installation		Wall mounted or install inside cabinet

2. General Specification

Main Control Function	Modulation mode	Optimized space voltage vector SVPWM modulation
	Control mode	SVPWM control (dead zone compensation for optimized low-frequency)
	Frequency precision	Digital Setting: max frequency × ±0.01%; Analog Setting: max frequency × ±0.2%
	Frequency resolution	Digital Setting: 0.01Hz; Analog Setting: max frequency × 0.1%
	Start frequency	0.40Hz ~ 20.00Hz
	Torque boost	Auto torque boost, manual torque boost 0.1% ~ 30.0%
	V/F curve	Five modes: constant torque V/F curve, 1 V/F curve mode by user and 3 kinds of torque-derating modes (2nd power, 1.7th power, 1.2nd power)
	Accelerate/Decelerate curve	Two modes: linear Acc/Dec, S curve Acc/Dec; seven kinds of Acc/Dec time, Maximum: 6000 minutes, the time unit (minute or second) is selectable

	DC brake	Initial frequency of DC braking: 0~15.00Hz Braking time: 0~60.0 s Braking current: 0~80%
	Power consumption brake	Built-in brake unit, can connect external brake resistor
	Jog	Range of jog frequency: 0.1Hz~50.00Hz, Acc/Dec time of jog 0.1~60.0s
	Built-in PI	Easy to form close loop control system
	Multi-step speed running	Multi-step speed work through built-in PLC or control terminals
	Textile wobble frequency	Adjustable preset frequency and center frequency
	Auto voltage regulation (AVR)	When the power system voltage changes, maintain the constant of output voltage
	Auto energy saving running	Auto-optimize V/F curve according to the load condition to realize energy saving operation
	Auto current limit	Auto-limit running current to avoid trip caused by overcurrent
	Fix-length control	The frequency inverter will stop running when reaching the fixed length
	Communication function	With RS485 port, support Modbus-RTU protocol. Be with master-slave multi-device linkage function
Operate function	Command channel	Operation panel setting; control terminals setting; serial port setting; three modes are exchangeable
	Frequency channel	Keyboard analog potentiometer setting; ▲, ▼ keys setting; function code digital setting; serial port setting; UP/DOWN terminal setting; analog voltage setting; analog current setting; pulse setting; combination setting; different setting modes can be switched
	Digital input channel	Forward/Reverse running command; 6 channels programmable digital input, can set 35 kinds of function, X6 support 0~20KHz pulse input
	Analog input channel	2 channels analog input, 4~20mA and 0~10V can be selected
	Analog output channel	1 channel analog output: 0~10V/4~20mA, can output setting frequency, output frequency
	Digital/pulse output channel	1 channel programmable open-collector output; 1 channel relay output; 1 channel 0~20KHz pulse output
Operation panel	LED Display	Can display setting frequency, output voltage, output current and other parameters
	External meter Display	Display output frequency, output current, output voltage and other physical quantities
	Button Lock	Lock all the buttons
Protection Function		Over current protection; over voltage protection; under voltage protection; over heat protection; over load protection
Optional parts		Brake parts, operation panel, extension cable of operation panel

1-3. Product appearance

VB3 series 0.4~0.75KW

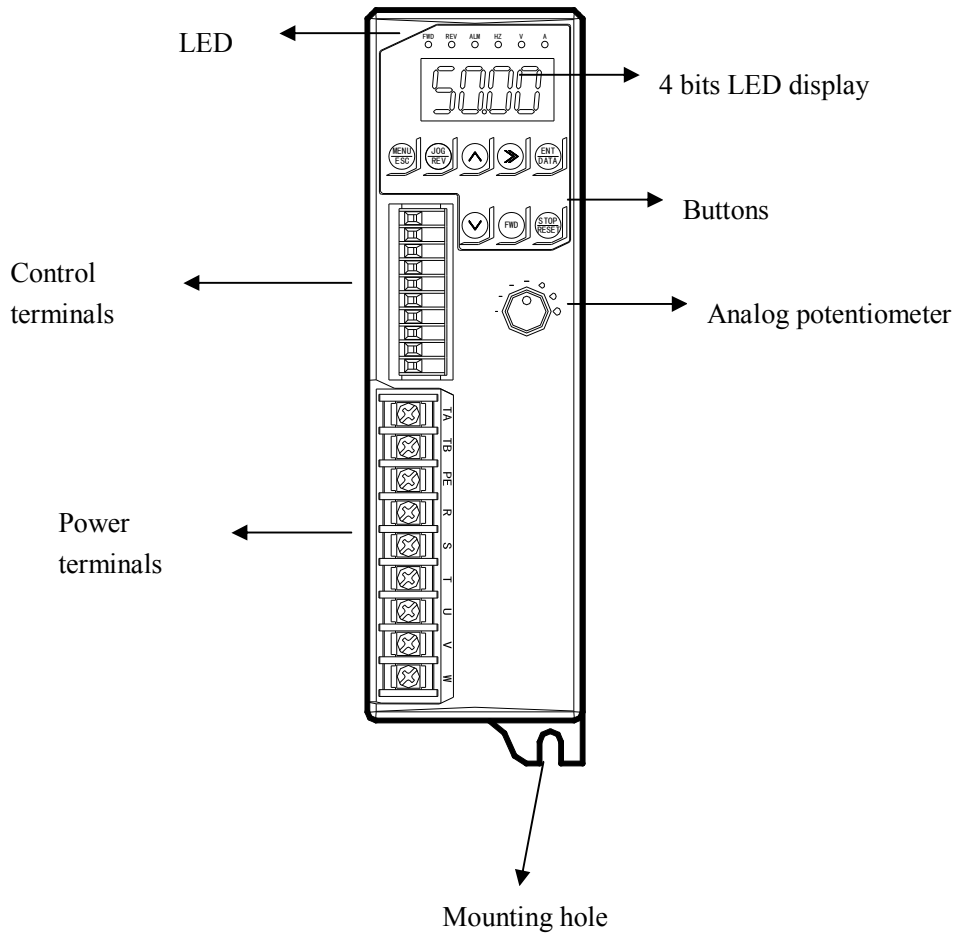

VB5 series single-phase 0.75~2.2KW
VB3/VB5 series 3-phase 0.75~3.7KW

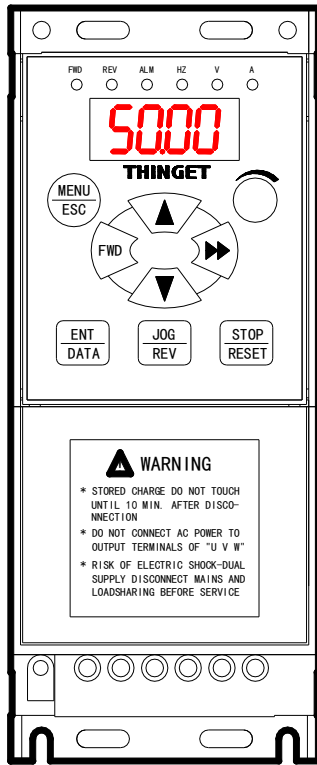

VB5 series 5.5KW~7.5KW

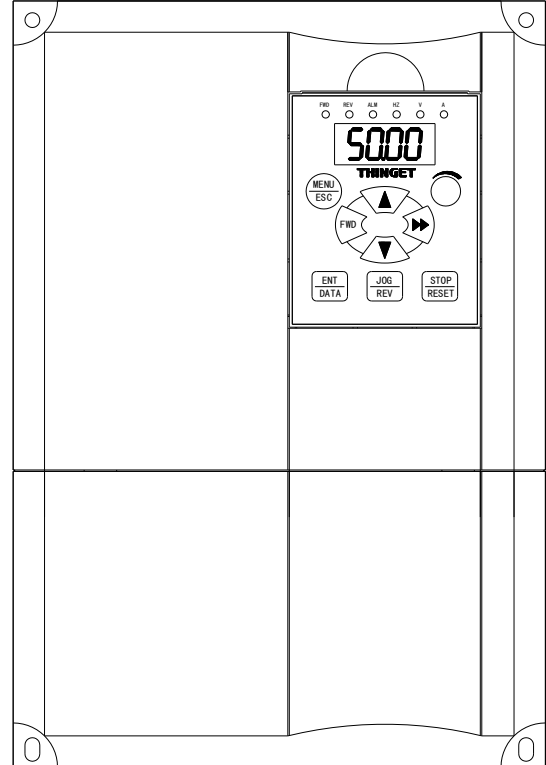

V5 series 11~18.5KW

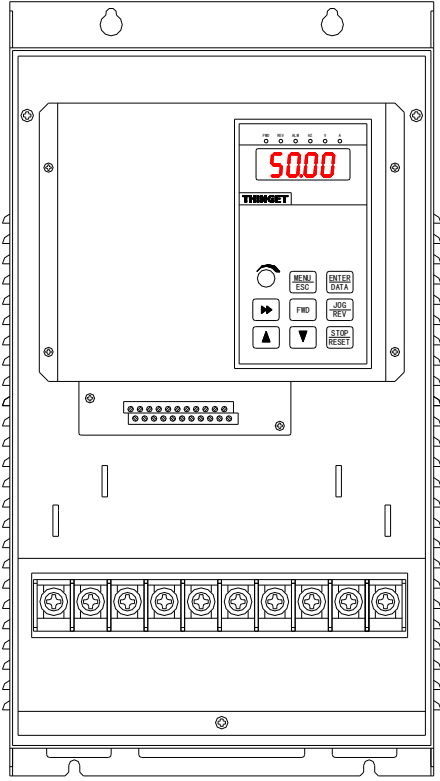

V5 series 22~55KW

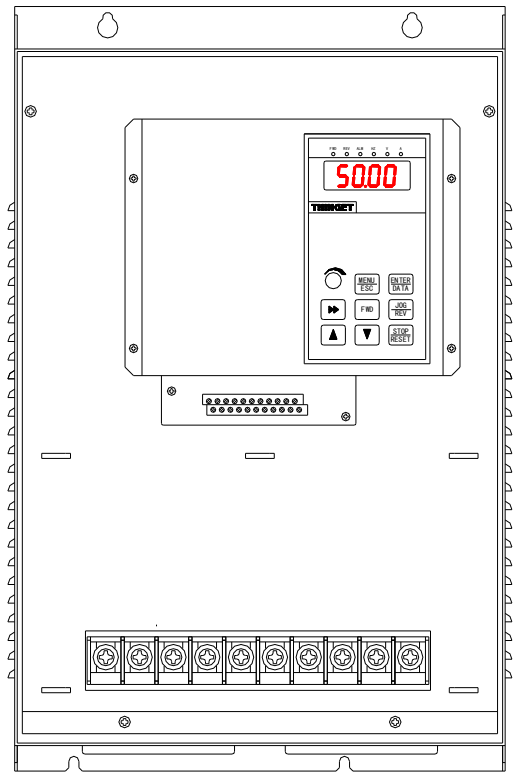

1-4. Product dimension

■ VB3 series 0.4~0.75KW

(Unit: mm)

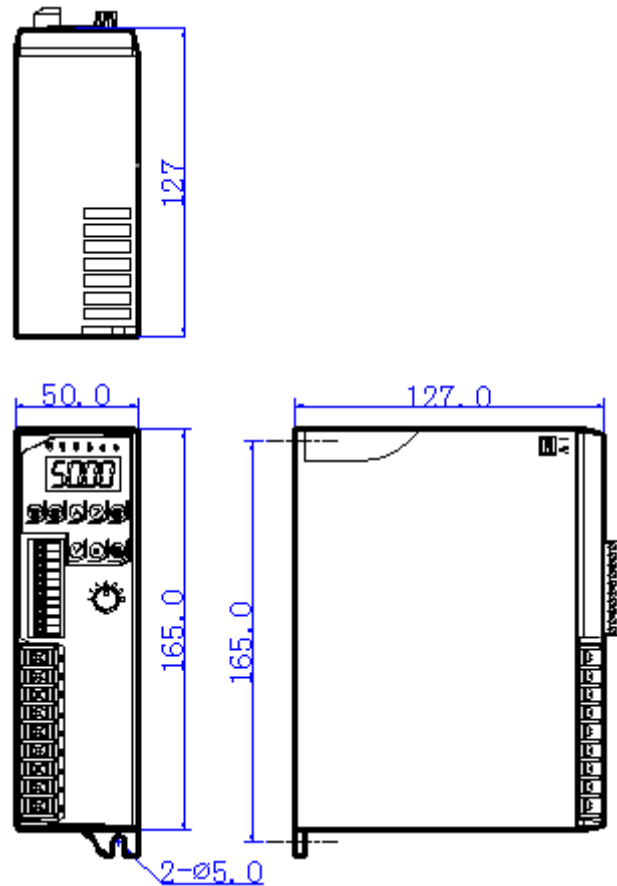

■ VB3, VB5 series 0.75~3.7KW

(Unit: mm)

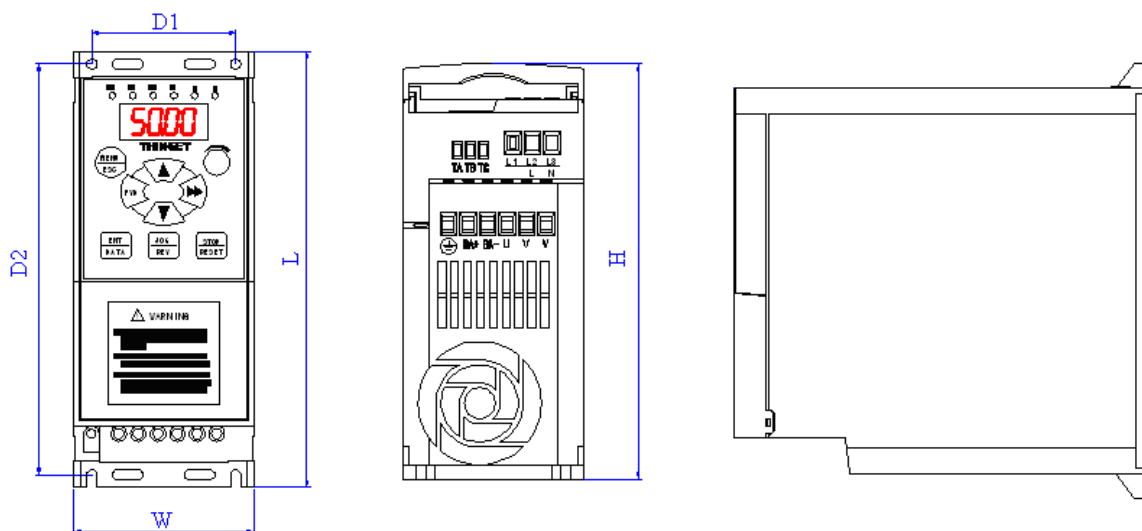

The details of the dimension:

Type	W	D1	L	D2	H
VB5-20P7	70	56	170	160	162
VB5-21P5					
VB5-22P2					
VB3/VB5-40P7	80	56	200	190	162
VB3/VB5-41P5					

VB3/VB5-42P2					
VB3/VB5-43P7					

■ VB5 series 3-phase 5.5~7.5KW

(Unit: mm)

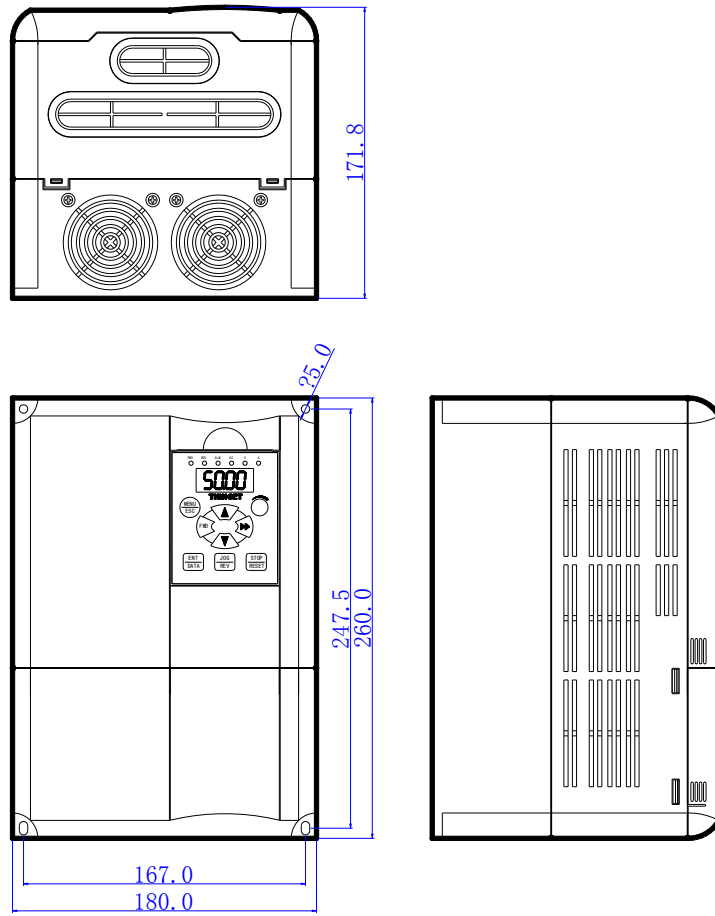

■ V5 series 3-phase 11~55KW

(Unit: mm)

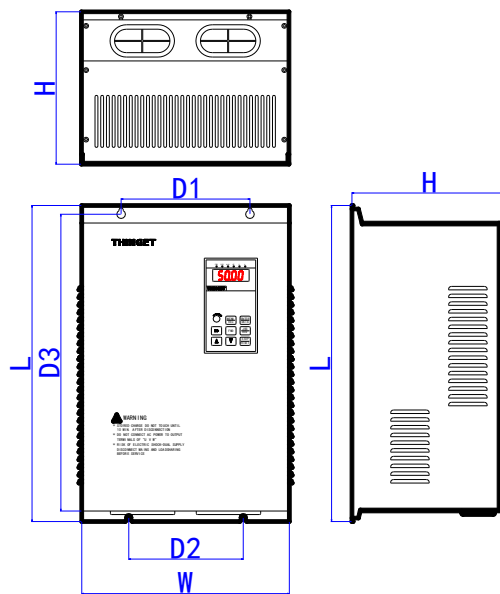

The details of the dimension:

Type	W	D1	L	D2	H	D3
V5-4011	230	120	420	160	218	400
V5-4015						
V5-4018						
V5-4022	290	180	450	210	217	430
V5-4030						
V5-4037	375	230	581	230	261	551
V5-4045						
V5-4055						

2 Installation and Wiring

2-1. Installation environment

2-1-1. Environment requirement

- Ambient temperature: $-10^{\circ}\text{C}\sim 40^{\circ}\text{C}$. The inverter should be derated when the temperature over 40°C , at the same time ventilation and heat dissipation should be enhanced.
- Far away from the location with direct sunlight, dust, floating fiber or metal powder.
- Mount in the location free of corrosive gas and combustible gas.
- Mount in the location free of condensation, and the humidity should less then 95%RH.
- Mount in the location where vibration less than $5.9\text{m/s}^2(0.6\text{G})$
- Far away from electromagnetism interfere source and other electric instruments sensitive with electromagnetism interfere.

2-1-2. Mounting location and space

- Mount the inverter vertically under general condition.
- The mounting space and distance are shown in Fig. 2-1.
- When several inverters are mounted up and down, air diversion plate should be fixed in the middle as shown in Fig. 2-2.

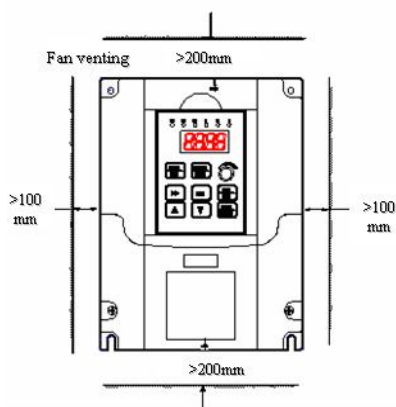

Fig. 2-1 Mounting Space

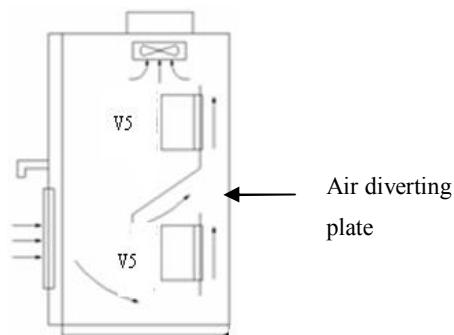

Fig.2-2 Mounting of Multi-Inverters

2-1-3. Mounting and removing

- Removing: Remove the four screws on the cover with phillips screwdriver
- Mounting: Align the mounting holes and then fix the screws.

2-2. Wiring



Caution

- Wiring after power off for at least 10 minutes, otherwise, an electronic short may occur.
- Do not connect AC power to output terminals U, V and W.
- Both the inverter and the motor should be safety grounded as there is leakage current inside the inverter. The diameter of grounding copper cable must be more than 3.5mm², grounding resistor must be less than 10ohm.
- Withstand voltage test of the inverter has been done in the factory, users would better not do it again.
- Do not install electromagnetic contactor, absorption capacitor or other resistance-capacitance absorption devices, as shown in Fig2-3.
- In order to make the input over-current protection and power off maintenance easily, the inverters should connect power supply via braker.
- The connection cable of relay I/O circuit (X1~X6, FWD, REV, OC, DO) should select the twisted-pair or shield cable with diameter over 0.75 mm². One terminal of the shield layer should be hung in the air and the other terminal should be connected with the inverter's grounding terminal E, the cable length should be less than 50m.



Danger

- Before layout operation, make sure the power supply of inverter is cut off, all the LED on the operate panel is black out and delay for more than 10 minutes.
- Wiring work can be performed after the voltage between internal electrolesis capacity “+” and “-” is below DC36V.
- Wiring work can only be done by trained and professional personnel.
- Before power on, please check if the power supply voltage is consistent with the inverter voltage level, otherwise device damage, human injuries and deaths may occur.

2-3. Wiring of main circuit terminals

2-3-1. Wiring diagram

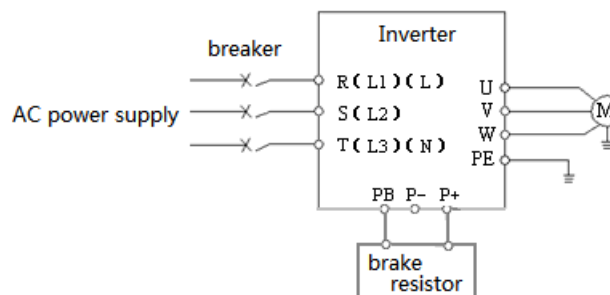

Fig. 2-3 Wiring of main circuit

2-3-2. Terminal assignment and description

Fig. A



Fig. B

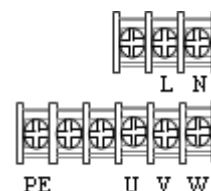

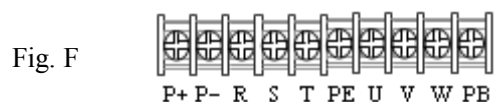

The relationship between main circuit terminals and product types:

Voltage level	Power (KW)	Figure	Series
220V	0.4~0.75	Fig. A	VB3
	0.75~2.2	Fig. B	VB5
380V	0.75~3.7	Fig. C	VB3
	0.75~3.7	Fig. D	VB5
	5.5~7.5	Fig. E	VB5
	11~18.5	Fig. F	V5
	22~30	Fig. G	V5
	37~55	Fig. H	V5

I/O terminals of main circuit:

Table 2-1 main circuit I/O terminals

Voltage	Terminal	Function
VB3, VB5 series Single phase 220V	L, N	Single phase AC 220V input
	U, V, W	Three phases AC output
	PE	Ground
VB3, VB5 series Three phases 380V	L1, L2, L3	Three phases AC 380V input (fit for power below 3.7KW)
	R, S, T	Three phases AC 380V input (fit for power below 3.7KW)
	P+, PB	Brake resistor (some types don't have brake unit)
	P+, P-	Generatrix + and -
	U, V, W	Three phases AC output
	PE	Ground
V5 series Three phases 380V	R, S, T	Three phases AC 380V input
	U, V, W	Three phases AC output
	P+, P-	Generatrix + and -
	P1, PB	Brake resistor
	PE	Ground

2-4. Basic running wiring

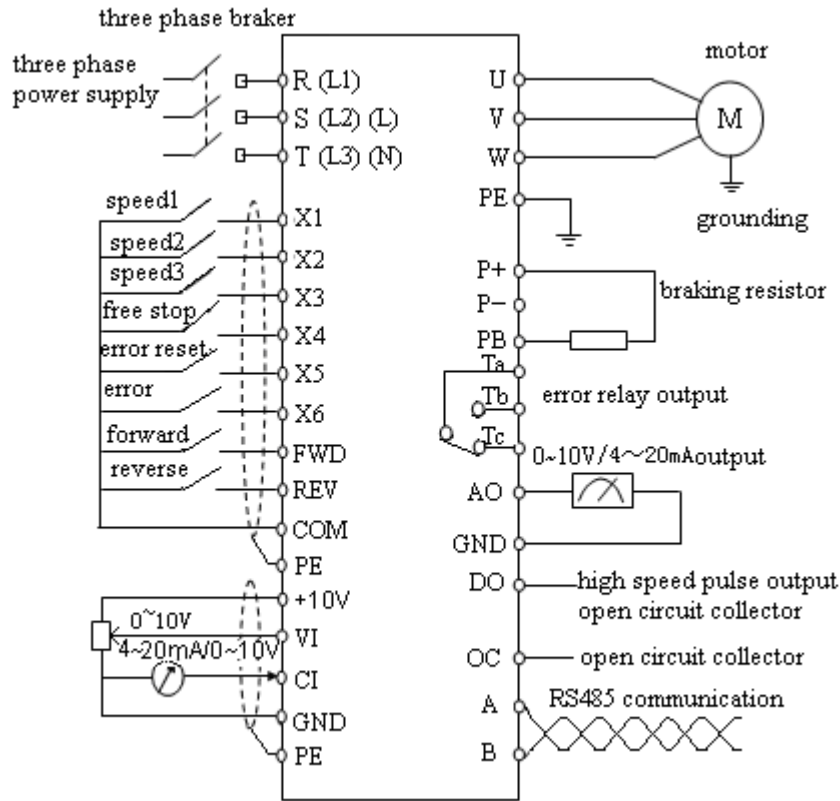

Note:

- (1) P- terminal is only used in 5.5KW and larger inverters.
- (2) L, N terminals are suitable for 220V single phase inverters.
- (3) L1, L2, L3 terminals are suitable for VB5 series 0.75~3.7KW three phases types.
- (4) VB5 series 0.75~3.7KW three phases have no digital input X5, analog input VI and digital output DO.
- (5) VB3/VB5 series single phase have no X4~X6, VI, AO, DO, OC, P+, P-, PB.
- (6) VB3 series 0.75~3.7KW three phases have no terminal X5, X6 and VI, DO, P+, P-, PB.

2-5. Setting and wiring of control circuit

2-5-1. Position and function of terminals and jumpers on control panel

Please open the front cover of inverter, there is the PCB board inside. The jumper is on the board.

0.4 ~0.75KW VB3 series inverter jumper position

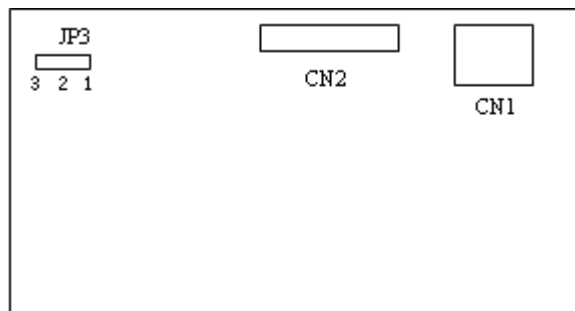

Fig 2—4(a) jumper position on control board

0.75~2.2KW VB5 series single phase inverter jumper position

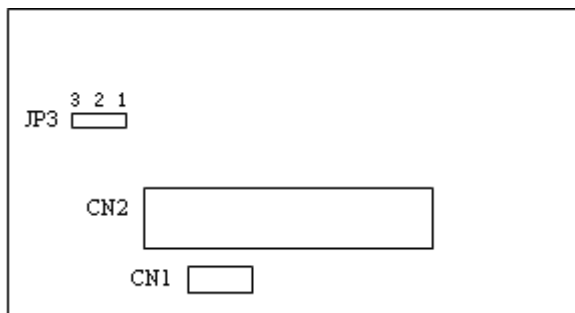

Fig 2—4 (b) jumper position

0.75~3.7KW VB3, VB5 series three phases inverter jumper position

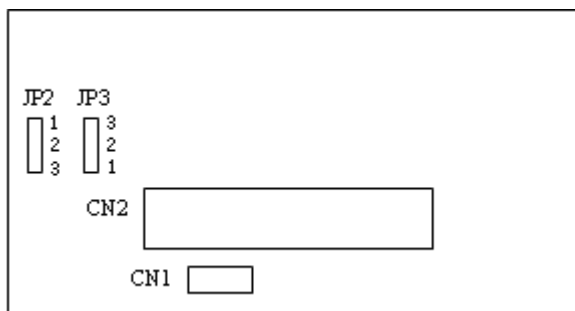

Fig 2—4 (c) jumper position

5.5~7.5KW VB5 series three phases inverter jumper position

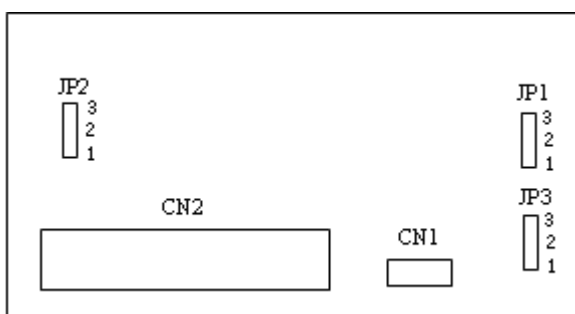

Fig 2—4 (d) jumper position

11~55KW V5 series inverter jumper position

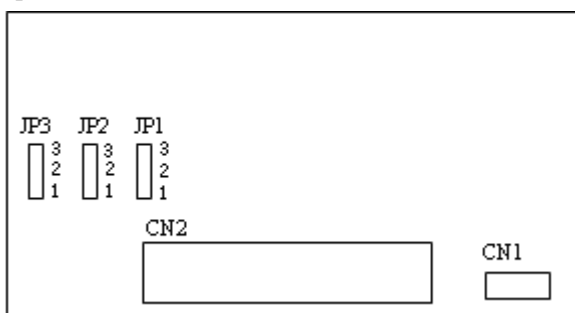

Fig 2—4 (e) jumper position

The position of jumpers are shown in Fig. 2-4, the function of jumper terminals are shown in Table 2-3 and the function descriptions of jumpers and their setting method are shown in Table2-2. Before running the inverter, make sure terminals wiring and jumpers setting have been done, more than 1mm² cables are recommended to use.

Table 2-2 Function of jumpers

Jumper	Function	Setup	Default Setup
JP1	Pulse output terminal DO power selection	1—2 connect: External power supply 2—3 connect: Inverter’s internal 24V power supply	External power supply
JP2	Analog output terminal AO output	1—2 connect: 4~20mA, AO terminal outputs current signal 2—3 connect: 0~10V, AO terminal outputs voltage signal	0~10V
JP3	CI current/voltage input modes selection	1—2 connect : V side: 0~10V voltage signal 2—3 connect : I side: 4~20mA current signal	4~20mA

2-5-2. Terminals on control panel

1. Functions of CN1 terminal are shown in Table 2-3:

Table 2-3 Function of CN1

Type	Terminal Mark	Name	Function Description	Specification
Relay output terminal	TA	Multi-function relay output terminals	Multi-functional relay output terminals. Please refer to function parameters P4.11 and description of output terminals	TA-TC: normal close
	TB			TA-TB: normal open
	TC			Contactor Capacity: AC250V/2A (COSΦ=1) AC250V/1A (COSΦ=0.4) DC30V/1A

2. Control circuit terminals CN2

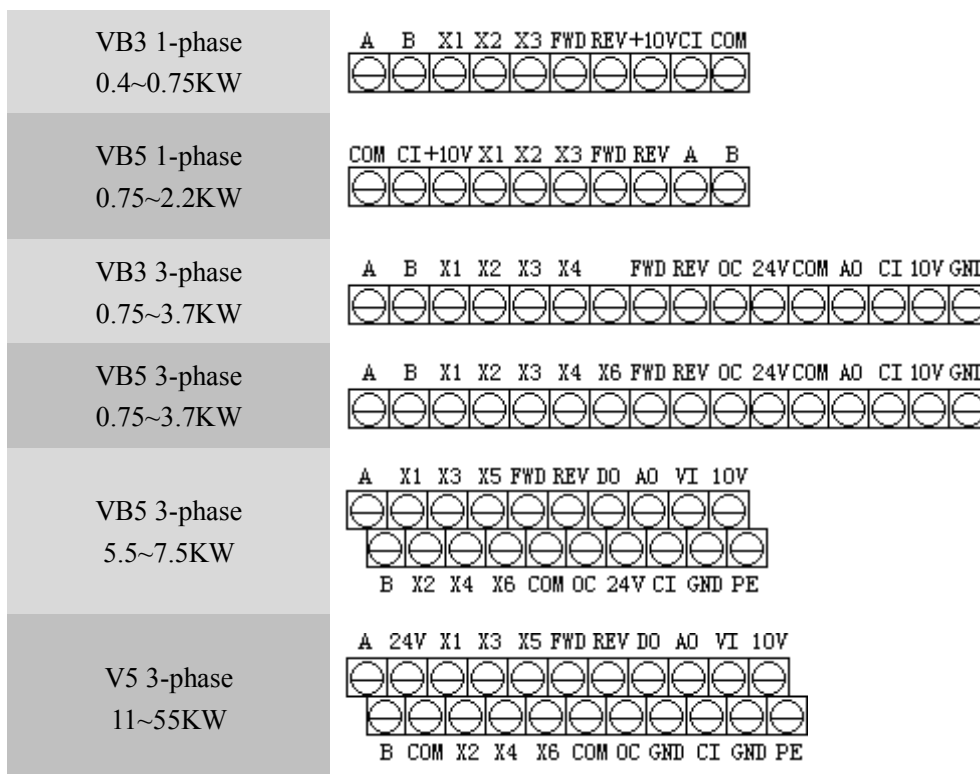
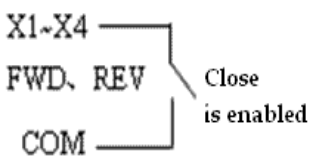

Fig. 2-5 Terminals on control panel

3. CN2 terminals' function description are shown as below:

Table 2-4 CN2 terminals' function description

Type	Terminal	Name	Terminal Function Description	Specification
Communication	A	RS485 port	RS485 difference signal +	standard RS485 port, please use twisted cable or shielded cable
	B		RS485 difference signal -	
Multifunction output terminal	OC	Open collector output terminal 1	Multi-function digital output terminal, refer to P4.10 for details (common terminals: COM)	optical coupling isolation output voltage range: 9~30V max output current: 50mA please refer to P4.10 for details
Pulse output terminal	DO	Open collector pulse output terminal	Multi-functional pulse output terminal, refer to P4.20, P4.21 for details (common terminals: COM)	Output frequency range: set P4.21, the max is 20KHz
Analog input	VI	Analog input VI	analog voltage input (reference ground: GND)	Input voltage range: 0~10V (input resistance: 47K Ω) Resolution: 1/1000
	CI	Analog input CI	Analog current/voltage input, voltage and current are selected by jumper JP3 and the default is current. (reference ground: GND)	Input voltage range: 0~10V (input resistance: 47K Ω) Input current range: 4~20mA (input resistance: 500 Ω) Resolution: 1/1000
Analog output	AO	Analog output AO	Analog voltage/current output, they are selected by jumper JP2 and the default is voltage which can indicate 7 values. (reference ground: GND)	Voltage output range: 0~10V Current output range: 4~20mA
Running control terminal	FWD	Forward running command	Forward/reverse digital command. Refer to P4.08 for details (instruction about 2-wire and 3-wire control function).	Optical coupling isolation input Input resistance: R=2K Ω Highest input frequency: 200Hz Input voltage range: 9~30V
	REV	Reverse running command		
Multifunction input terminal	X1	Multifunction input 1	Multi-function digital input terminals, refer to parameter P4. (common terminal: COM)	
	X2	Multifunction input 2		
	X3	Multifunction input 3		
	X4	Multifunction input 4		
	X5	Multifunction input 5		
	X6	Multifunction input 6		
Power supply	24V	+24V power supply	Supply +24V power supply (negative terminal: COM)	-
	10V	+10V power supply	Supply +10V power supply (negative terminal: GND)	Max output current: 50mA
	GND	+10V power supply common terminal	Reference ground of analog signal and +10V power supply	COM is isolated with GND inside inverter
	COM	+24V power supply common terminal	Digital signal I/O common terminal	
Shield	PE	Shield terminal		

2-5-3. Analog I/O terminal wiring

1. The wiring of VI terminal voltage signal input

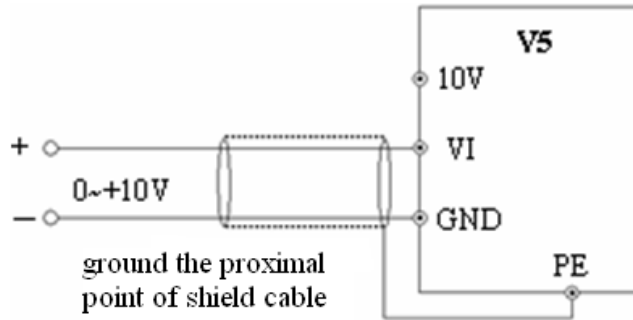

Fig. 2-6 VI terminal wiring diagram

2. CI terminal analog input, jumper select voltage input (0~10V) or current input (4~20mA):

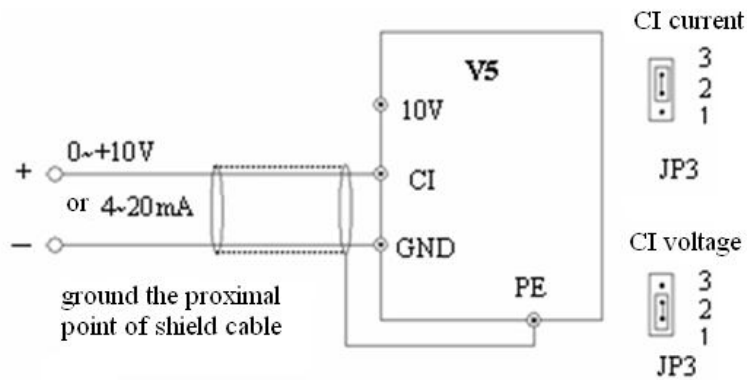

Fig. 2-7 CI terminal wiring

3. Wiring for analog output terminal AO

Analog output terminal AO can display various physical quantities. The output voltage is 0~10V, output current is 4~20mA.

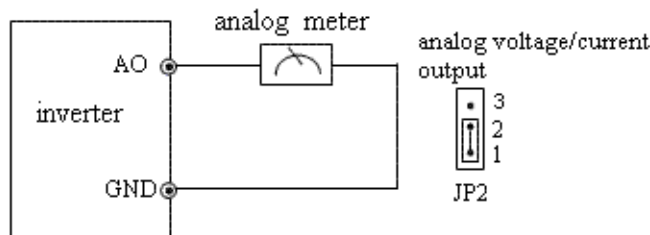

Fig. 2-8 Analog output wiring

Note:

- (1) When using analog input, you can connect filter capacitor or common mode choke between VI and GND, or CI and GND.
- (2) Because analog input signal is easily interfered by outside, the shield cable is required, the cable length must be short and the shield layer must be grounded well.

2-5-4. Connection of communication terminals

The communication port of this inverter is standard RS485 port.

With the following wiring methods, you can build up control system of one-host-one-slave or one-host-multi-slaves. Also, the superior device (PC or PLC) can realize the functions such as real time monitor inverter, remote control, highly automated motion control.

- Connection of inverter RS485 port and superior device:

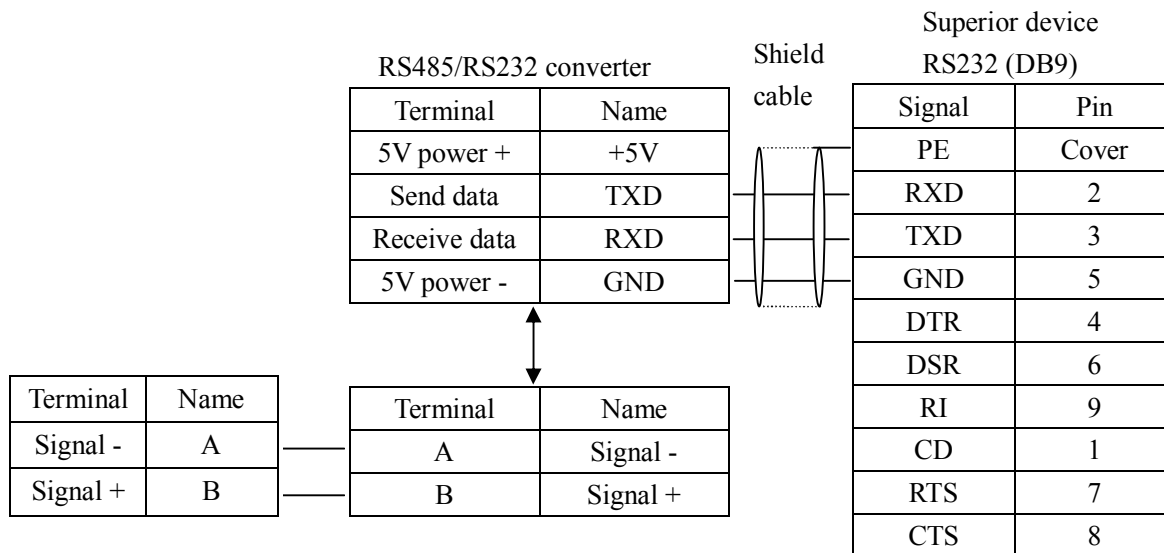

Fig. 2-9 RS485-(RS485/232)-RS232 cable connection

- Many inverters can be connected together through RS485, the PLC(or PC) is the host device, as shown in Fig.2-10; Also, you can select one inveter as host and the other inverters are slaves, as shown in Fig.2-11. The more inverters are connected, the communication system will be interfered seriously, the following wiring is recommended.

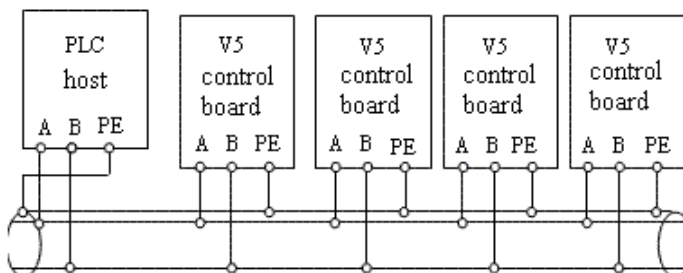

Fig. 2-10 Connection of PLC and inverters

(Inverters and motors are all grounded well)

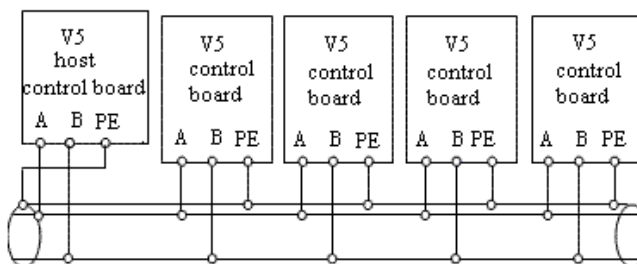

Fig. 2-11 Connection of several inverters

(Inverters and motors are all grounded well)

If the communication is still failed with the above connection methods, you can adopt the following methods:

- (1) Use separate power supply for PLC or isolate its power supply.
- (2) Use magnetism ring for the cable and reduce the inverter’s carrier frequency.

2-6. Mounting guide according with EMC

As the inverter output wave is PWM, electromagnetic noise will generate while it is working. To reduce the inverter interference for other devices, this chapter introduces the EMC mounting method in the following aspects: control the noise, local wiring, grounding, leak current, power supply filter.

2-6-1. Control the noise

1. Noise type

The noise made by inverter may affect the nearby equipments and the effect is related to inverter’s control system, anti-noise and anti-jamming ability of the devices, wiring environment, safety distance, grounding method and other factors. The noise contains the following types: electrostatic induction, circuit transmit, space transmit, electro magnetic induction and so on.

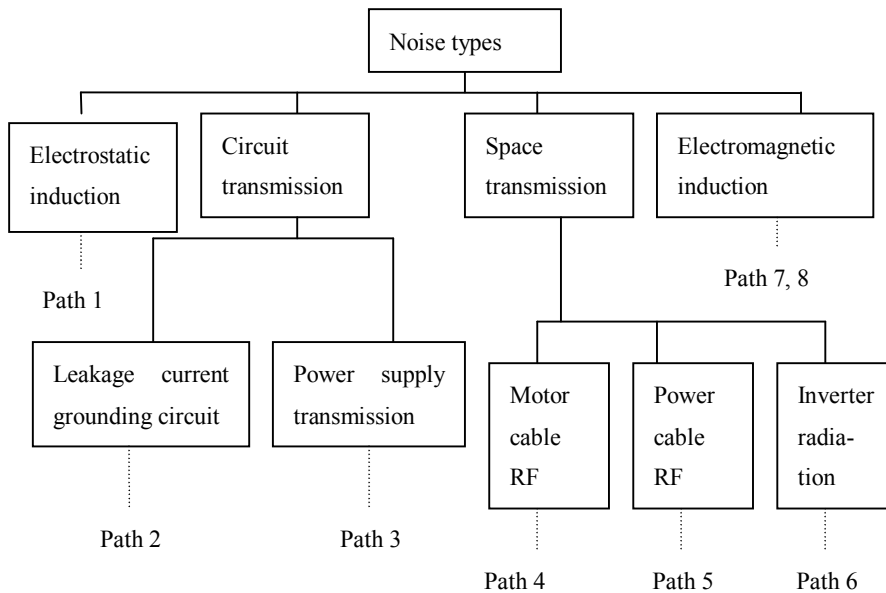

2. Essential countermeasure for suppressing noise

Table 2-5 solution for control noise

Noise transmit path	Solution
2	When the ground cable of external equipment forms a loop with the inverter, the equipment may operate incorrectly caused by leakage current of inverter grounding cable. The problem can be solved if the equipment is not grounded.
3	If the external equipment shares the same AC supply with the inverter, the inverter’s noise may be transmitted along its input power supply cables, which may cause interference to other external equipments. Take the following actions to solve this problem: Install noise filter at the input side of the inverter, and use an isolation transformer or power filter to prevent the noise from disturbing the external equipment.

4,5,6	<p>(1)The equipment and the signal cables should be far away from the inverter. The signal cables should be shielded and the shielding layer should be grounded. The signal cables should be located far away from the input/output cables of the inverter. If the signal cables must cross over the power cables, they should be placed at right angle to one another.</p> <p>(2) Install high-frequency noise filter (ferrite common-mode choke) at the input and output of the inverter to prevent the RF interfere of power lines.</p> <p>(3) Motor cables should be placed in a tube thicker than 2mm or buried in a cement slot. Power cables should be placed inside a metal tube and be grounded by shielding layer (Motor cable should use 4-core cable, one of the cores should be grounded near the inverter and another point should be connected to the motor's cover).</p>
1,7,8	<p>Don't put the strong and weak electricity cables in parallel or bundle these cables together. Other devices should also be away from the inverter. The devices wire should be away from the I/O of the inverter. The signal cables and power cables should be shielded cables. Devices with strong electric field and magnetic field should be away and orthogonal from the inverter.</p>

2-6-2. Local wiring and grounding

- (1) The cable connected inverter and motor (cables from U, V, W points) should not parallel with power supply cable (R, S, T or L, N terminal input wire). The distance should be more than 30cm.
- (2) Inverter's output cables from U, V, W terminals is recommend to put in metal tube or slot.
- (3) Control signal cables should be shield and the shield layer should be connected with inverter's PE terminal, then ground the point near the inverter.
- (4) The grounding cable of inverter's PE terminal should be connected to ground directly. It can't connect to other devices' grounding cables.
- (5) Don't put the signal cables in parallel with the power cables (R, S, T or L, N with U, V, W) or bundle these cables together, at least 20~60 cm distance should be kept (related with power current), If the signal cables and power cables needed to be intersected, they should be vertical to each other, as shown in Fig2-12.

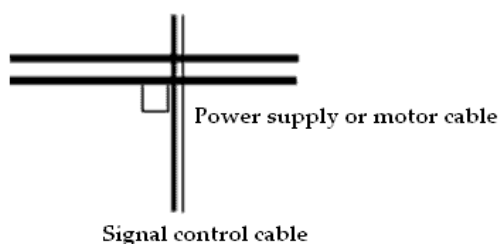

Fig. 2-12 Wiring requirement of system

- (6) The weak electricity grounding cable such as control signal and sensors should be separated with strong electricity grounding cable.
- (7) Do not connect other devices to inverter's power input terminals (R, S, T or L, N).



3 Operating Instructions

3-1. Run the inverter

3-1-1. Command channel of inverter

We can control the inverter's START, STOP, JOG and other running actions by three command channels.

1. Operation panel

Control by ,  and  keys on the operation panel (default setting)

2. Control terminals

FWD, REV, COM can form 2-wire control; one terminal of X1~X6 and FWD, REV can form 3-wire control.

3. Serial port



The operations such as START, STOP can be controlled by other devices which can communicate with the inverter.

You can select the command channels via parameter P0.03 or via multi-functional input terminal (P4.00~ P4.07 function 23, 24).

Warning: The user must debug the system after changing the command channel to make sure it can meet the system requirement, otherwise device damage and physical injury will happen.

3-1-2. Frequency setting channel

In common operating mode, there are 8 channels to set the frequency:

- 0: keyboard analog potentiometer
- 1:  and  keys on the operate panel
- 2: Function code on the operate panel
- 3: Terminals UP/DOWN
- 4: Serial port
- 5: Analog VI
- 6: Analog CI
- 7: Pulse terminal (PULSE)
- 8: Combination

3-1-3. Running state

There are two running state: stopping and running.

Stopping state: After the inverter powered on and initialized, if no operating command is input, the inverter will enter standby state.

Running state: The inverter enters running state after it receives running command.

3-1-4. Running modes

V5 inverter has 5 kinds of running modes which can be sequenced according to the priority: Jog running→Close loop running→PLC running→Multi-speed running→Simple running, as shown in Fig. 3-1.

0: Jog running

When the inverter is in the stop state, it will running according to jog frequency (refer to P3.06~P3.08 for details) after receiving jog running command (e.g after pressing  key)

1: Close loop

If the close loop running function is enabled (P7.00=1), the inverter will enter close loop running mode, that is, adjusting PI according to the reference and feedback value (see parameter P7), PI adjuster output is the essential command of inverter output frequency. Close loop running can be disabled by multi-function terminal (function No.27) and the inverter will switch to a lower priority running mode.

2: PLC running

If PLC function is enabled (the lowest bit of P8.00≠0), the inverter will enter PLC running mode and run in the pre-defined mode (refer to parameter P8). PLC running can be disabled by multi-function terminal (function No.29) and the inverter will switch to a running mode with low priority.

3: Multi-speed running

Select Multi-frequency 1~7 (P3.26~P3.32) to realize multi-speed running by no-zero combination of multi-function terminal (function No.1, 2, 3)

4: Common running

Common running is open loop running mode.

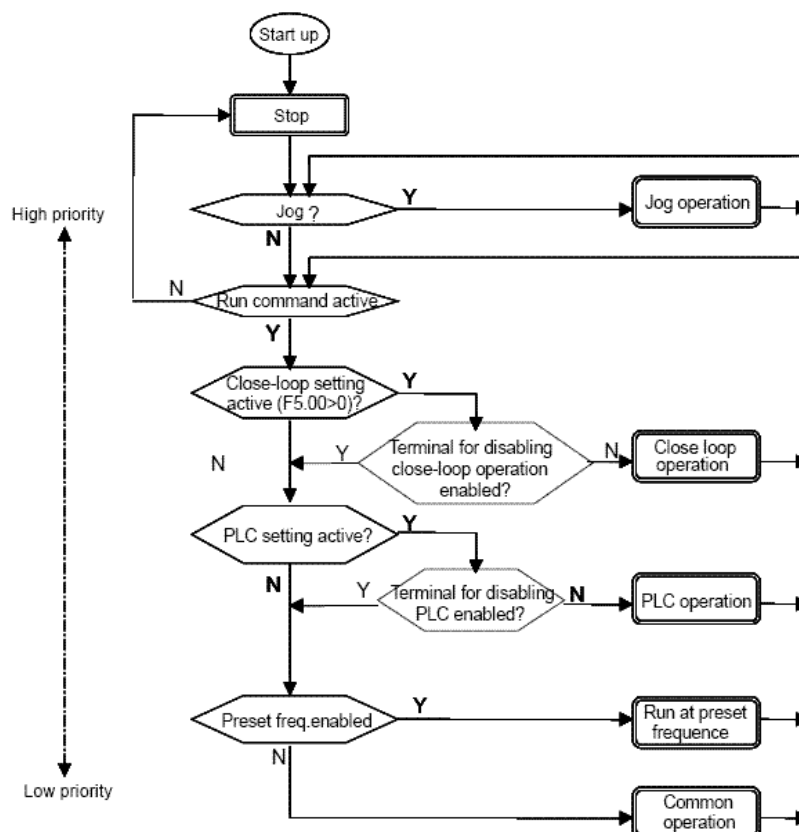

Fig. 3-1 Running state

Except “Jog running”, other 4 kinds of running modes can be enabled with multi-frequency. Besides, “PLC running”, “multi-speed running”, “common running” can be used as swing frequency.

3-2. Use the keyboard

3-2-1. Keyboard layout

Start, speed, stop, brake, running parameter setting and control of the peripheral can be performed by inverter’s operation panel and control terminals; operation panel is shown in Fig.3-2.

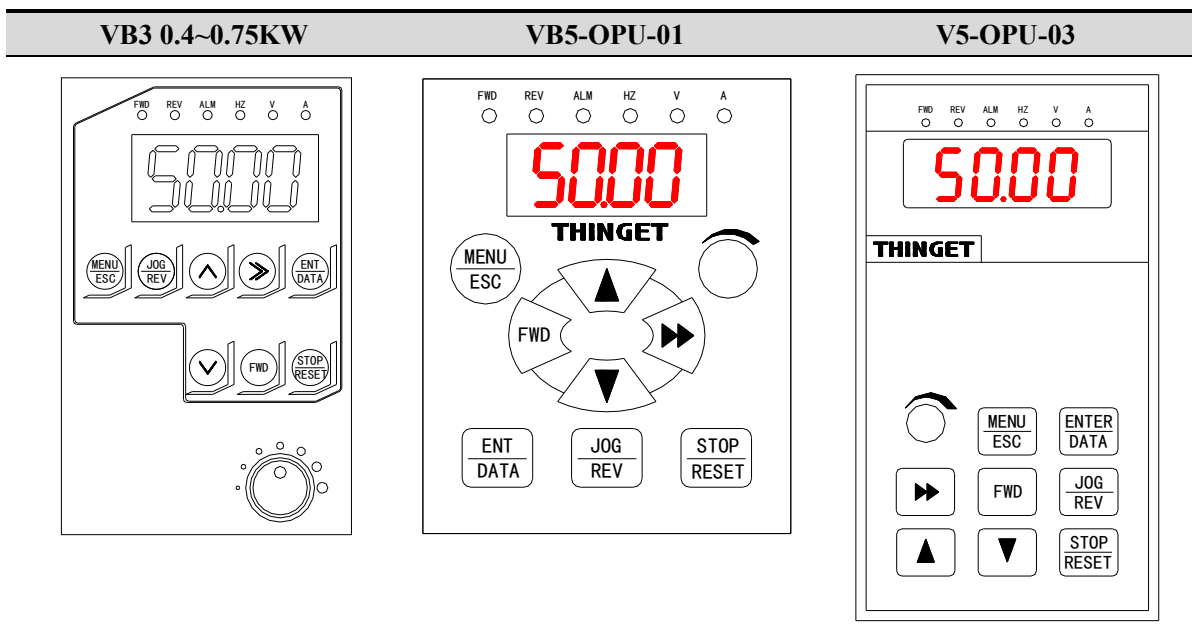



Fig. 3-2 Illustration of operation panel

3-2-2. Keyboard function

There are 8 keys and 1 potentiometer on the operate panel and the functions are shown in the following table.

Key	Name	Function
	Forward running	In operate panel control mode, press this key to run forward
	Stop/Reset	In operate panel control mode, press this key to stop running. In error mode, press it to return to normal state.
	Program/Exit	Enter or exit programming state
	Jog/Reverse run	P3.45=0, jog running P3.45=1, reverse running
	Increase	Increase data or function code
	Decrease	Decrease data or function code
	Shift	In editing state, press this key to select the bit to be changed; in other state, press this key to see the monitor parameters.

	Save/switch	In program state, press this key to enter the next menu or save the parameters.
	Analog potentiometer	When P0.01=0, adjust potentiometer to change the inverter's output frequency.

3-2-3. Function description of LED and indicator

The operation panel consists of 4-bit 8-segment LED, 3 unit indicators and 3 state indicators. The three unit indicators have 6 different combinations and each combination corresponds to one unit while setting parameters. The relationship between the combination of the indicators and the unit are shown in Fig.3-3.

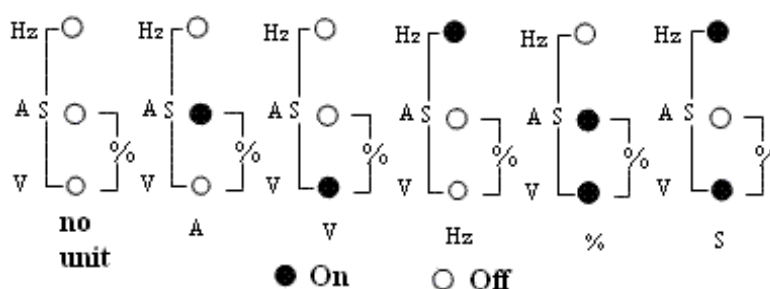

Fig. 3—3 Unit represented by combination of the indicators

3 state indicators locate above the LED in the operate panel. From left to right: forward indicator FWD, reverse indicator REV, alarm indicator ALM. The functions of these indicators are shown in Table3-1

Table 3-1 Functions of status indicators



Item		Function	
Display function	LED		Display inverter's current status parameters and setting parameters
	State indicator	FWD	Forward running indicator, inverter outputs positive phase, the motor will run forward after connecting to the inverter
		REV	Reverse running indicator, inverter outputs negative phase. The motor will run reverse after connecting to the inverter
		ALM	This indicator will light when the inverter is alarming.
		If FWD and REV indicators all light, it means that the inverter are in DC braking mode	

3-2-4. Display of the operation panel

The inverter's operation panel can display four parameters in stopping, editing, alarming and running.

1. Stop display

When the inverter stop, operation panel displays monitor parameters. Generally, it will display setting frequency (b-01 monitor parameter). As shown in Fig.3-4 B, the indicator on the top right displays the unit.

Pressing  key can cycle display other monitor parameters in stopping status (the first seven parameters in B group are fault displayed and the other parameters can be defined by function code P3.41 and P3.42, please refer to Chapter 5 for details). Press  to enter default display parameter b-01(setting frequency), otherwise it will always display the last monitor parameter.

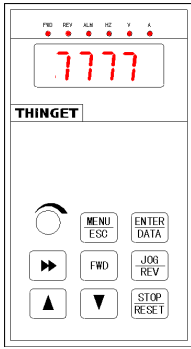

Fig.A Power on and Initialize, display the dynamic picture

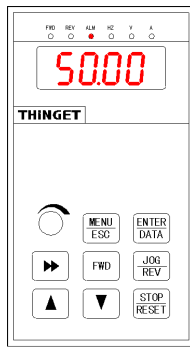

Fig. B Stop status, display the stop parameters



Fig. C Running status, display the running parameters

Fig. 3-4 Display during initialize, stop and run

2. Parameters displayed in running status

When the inverter receive running command, it starts to enter running status and operation panel will display running monitor parameters, the default parameter is output frequency (b-00),as shown in Fig.3-4 C, the unit indicator on the top right indicates the unit.

Press **▶▶** key can cycle display parameter in running status (defined by function code P3.41 and P3.42).While displaying, press **ENTER DATA** key to shift to the default parameter b-00 (output frequency), Otherwise, the operation panel will display the last monitor parameter constantly.

3. Alarm information

When then inverter detects error signal, the panel will display error code, the code will flicker to catch your attention as shown in Fig.3-5; Press **▶▶** key to view the relative error parameters in stopping status, and then press **ENTER DATA** to switch to error code display.

If you want to view error information, press **MENU ESC** to view P6 parameter in editing status.After you finding out and solve the problem, the inverter can be reset by **STOP RESET** key or control terminals or communication command. The error code will not disappear until the error is solved.

Note: For some serious error such as over current, over voltage etc, please do not reset the inverter and run until you solve the problem, otherwise the inverter may be damaged.

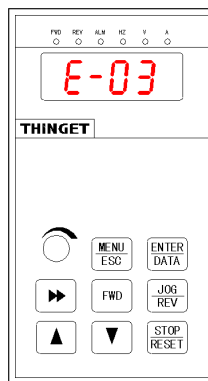

Fig.3-5 Alarming display status

4. Editing status

pressing **MENU ESC** key to enter editing status in stopping ,running or alarming status (if set password, you should input correct password to enter, refer to P0.00 and Fig 3-9 for details).This status can be displayed in three classes menu, they are: code group→code No. →code parameter, you can enter the sub-menu by pressing **ENTER DATA** .In code parameter status, press **ENTER DATA** to save parameter and press **MENU ESC** to exit without saving.

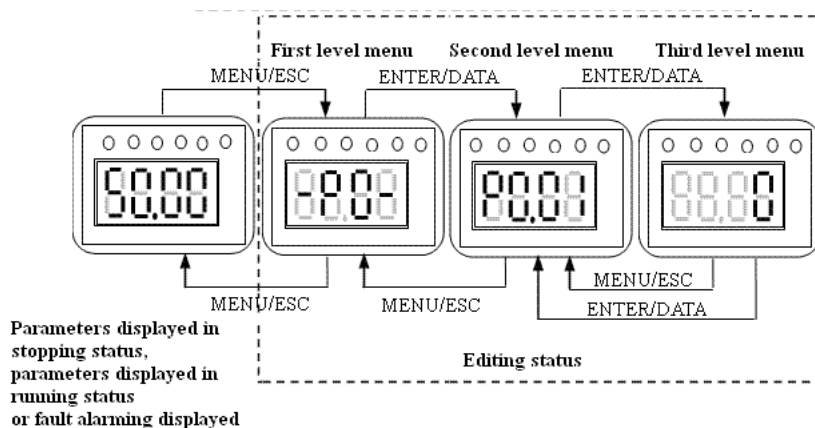

Fig. 3-6 Editing status

3-2-5. Panel operation method

The following show how to do various operations through the operation panel.

1. Parameter Display

Press **▶▶** key to display parameter group b. First display the parameter No, then display parameter value after one second. The shift method is shown below in Fig 4-7

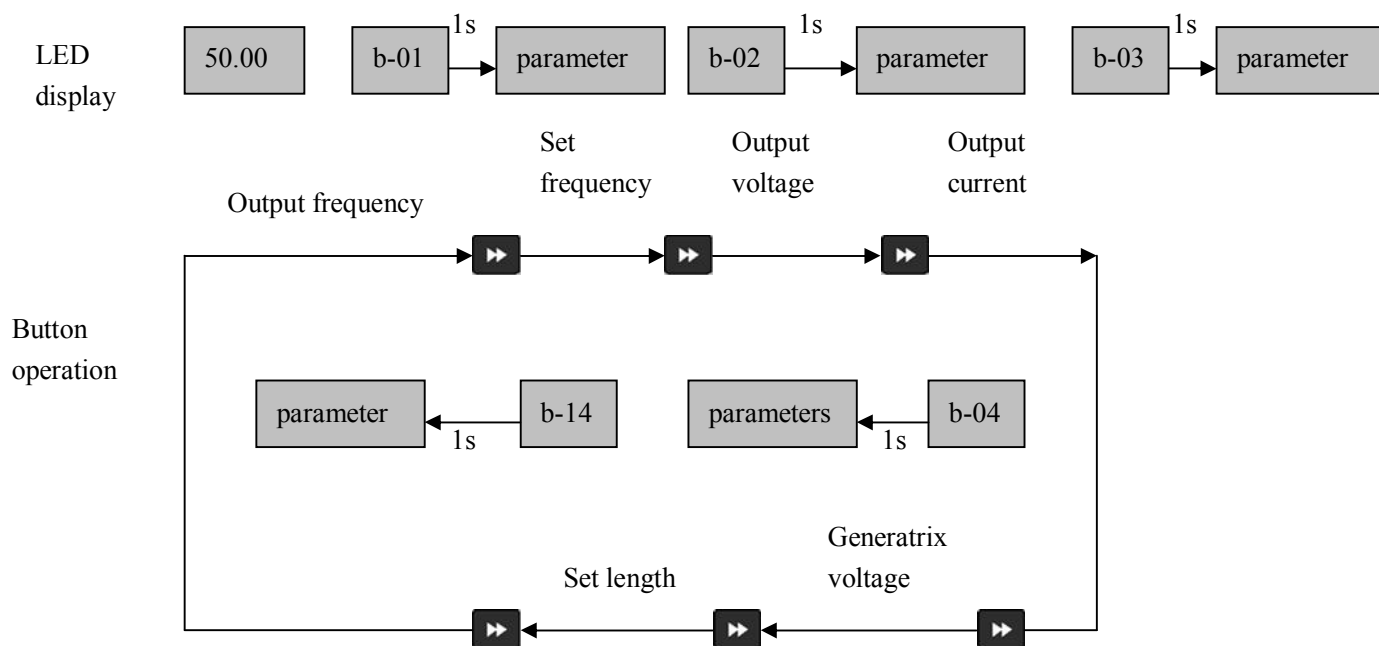

Fig. 3-7 Setting the parameters in running status

- 1) The default setting is to display parameter b-00~b-06, you can view other status parameters by changing P3.41 and P3.42.
- (2) When you want to view status monitor parameter, press **ENTER DATA** to enter default monitor parameter display status. The default monitor parameter in stopping states is setting frequency and in running states is output frequency.

2. Function parameter

Take the following as an example: change function parameter P3.06 from 5.00Hz to 8.50Hz.

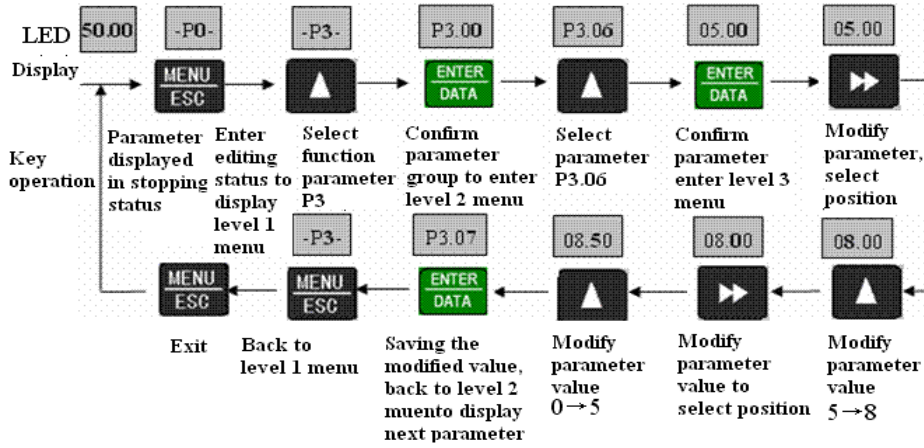

Fig. 3-8 Parameter editing

In the third level menu, the parameter can't be changed if no bit is flashing, the possible reasons are:

- (1) The setting of this parameter can not be changed, such as the actual detected parameters or recorded parameters.
- (2) This parameters can only be changed in stopping state and can not be changed in running state.
- (3) Parameters have been protected. If the lowest bit of P3.01 is set to 1 or 2, all the parameters can not be changed. If you really want to change the setting, please set P3.01 to 0 in advance.

3. Jog

Suppose the current running command channel is operate panel, machine is standby, jog frequency is 5Hz:

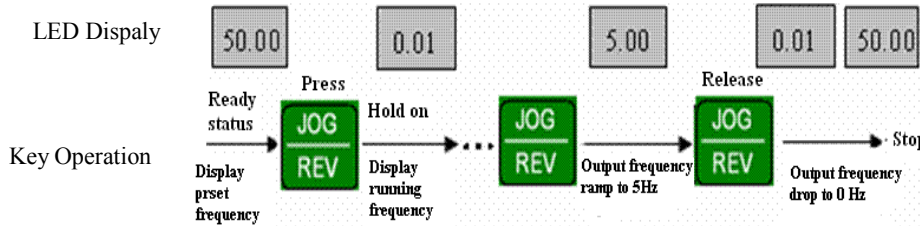

Fig. 3-9 Jog Operation

4. Set user password

Set password PF.01 as "2345". The bold bit indicates flashing digit.

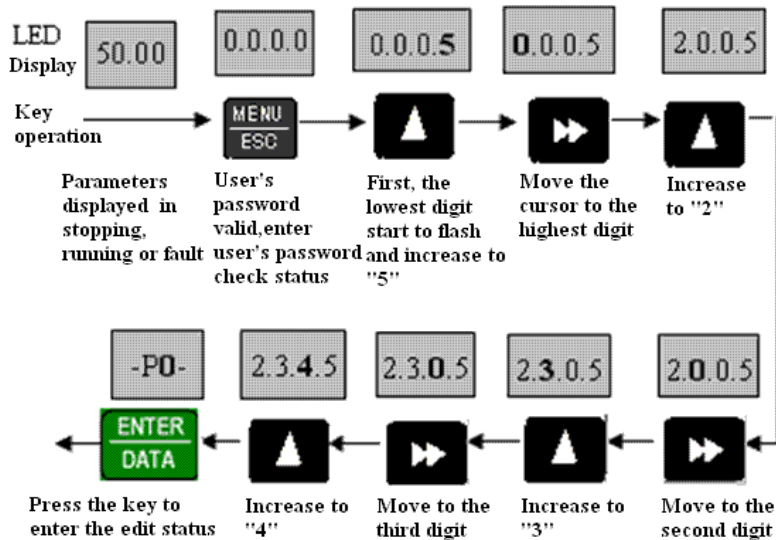

Fig. 3-10 Input user's password

5. Check error parameters:

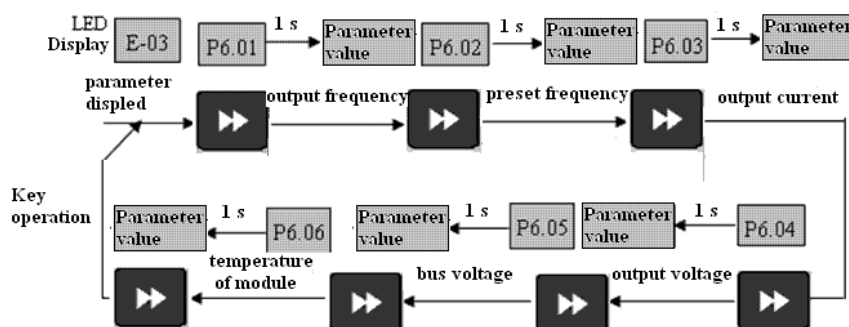

Fig. 3-11 Check operation in error status

Note:

- (1) Press key to check parameter P6 in error code display mode, the range is P6.01~P6.06, press key, parameter No. will firstly displayed and the parameter value will be displayed after 1s.
- (2) While checking, press key to back to error code display.

6. Setting frequency via and

Suppose it is in stopping parameter display mode, P0.01=1, the operation mode is shown below:

- (1) Frequency adjustment adopt integral mode;
- (2) When always pressing , the digital increases from lowest bit of LED, then ten bit starts to increase, so does hundred bit and thousand bit. If you release and press it again, it increases from the lowest bit again.
- (3) When always pressing , the digital decreases from lowest bit of LED, then ten bit starts to decrease, so does hundred bit and thousand bit. If you release and press it again, it decreases from the lowest bit again.

7. Lock the panel

If the panel is unlocked, press key for five seconds to lock the panel.

8. Unlock the panel

If the panel is locked, press key for five seconds to unlock the panel.

3-3. Power on the inverter

3-3-1. Checking after power on

Please wire the inverter according to “Wiring” in this manual.

3-3-2. Power on the inverter for the first time

After checking the wiring and AC power, switch on the AC power supply to electrify the inverter. The inverter's panel will display dynamic screen and then the contactor closes. When the LED displays preset frequency, the inverter initialization is completed. The procedure is shown as in Fig3-12.

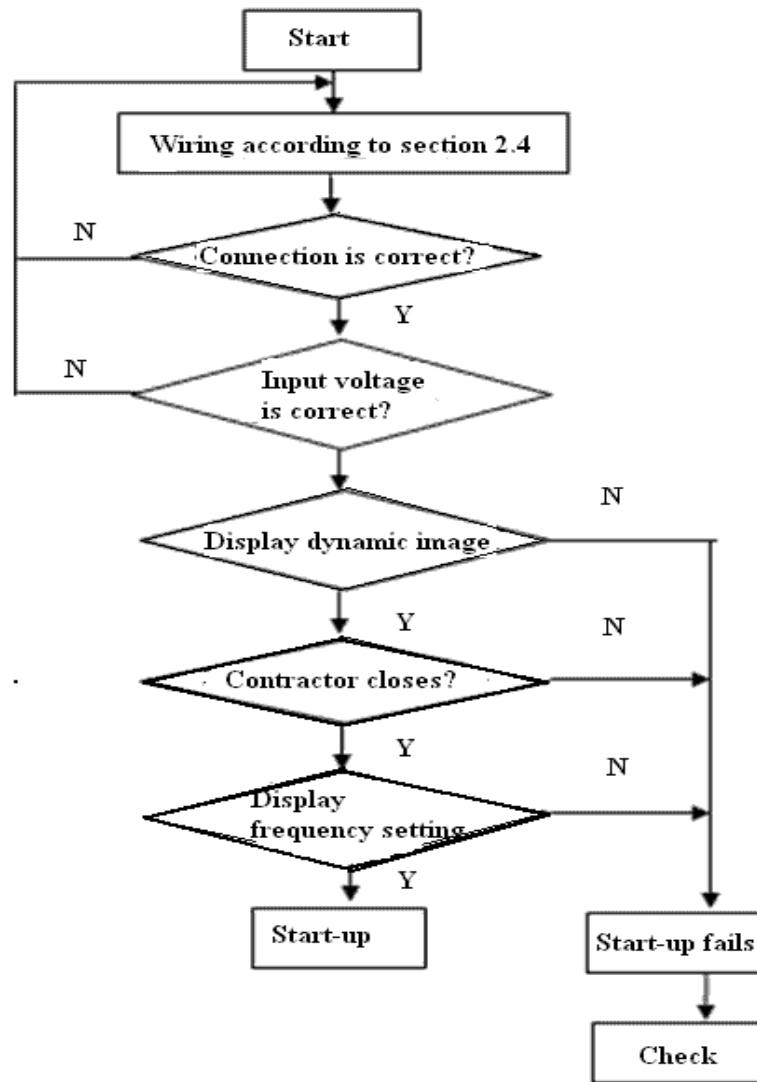

Fig. 3-12 Procedures of starting the inverter for the first time

4 Function Parameters

4-1. Function code

○: Parameters can be changed while running

×: Parameters can not be changed while running

*: Parameters can only be read, can not be changed

1. Basic running parameters (Group P0)

Group P0: Basic running parameters					
Parameter	Name	Setting Range	Minum unit	Default setting	Change
P0.00	Control mode selection	0: V/F control 1: open-loop vector control	1	0	×
P0.01	Frequency setting mode	0: potentiometer on the panel 1: Increase/Decrease key 2: digital setting 1, via keys on the panel 3: digital setting 2, via terminal UP/DOWN 4: digit setting 3, via serial port 5: VI analog input (VI-GND) 6: CI analog input (CI-GND) 7: Pulse input (PULSE) 8: Combined setting mode (refer to P3.00)	1	0	○
P0.02	Digital set the running frequency	P0.19 max frequency ~ P0.20 min frequency limit	0.01HZ	50.00HZ	○
P0.03	Running command selection	0: operation panel 1: Teminal 2: serial port	1	0	○
P0.04	Running direction setting	Lowest bit: 0: jog forward via panel 1: jog reverse via panel Ten bit: 0: enable to reverse running 1: prohibit reverse running	1	00	○
P0.05	Run forward/reverse dead zone time	0.0~120.0s	0.1s	0.1s	○
P0.06	Highest ouput frequency	50.00Hz~500.00Hz	0.01Hz	50.00Hz	×
P0.07	Basic running frequency	1.00Hz~500.00Hz	0.01Hz	50.00Hz	×
P0.08	Highest output voltage	1~480V	1V	Inverter rated voltage	×
P0.09	Torque boost	0.0%~30.0%	0.1%	2.0%	○
P0.10	Cut-off frequency for torque boost	0.00Hz~basic running frequency P0.07	0.00	25.00Hz	○
P0.11	Torque boost mode	0: manual 1: automatic	1	0	○
P0.12	Carrier frequency	1.0K~14.0K	0.1K	8.0K	×
P0.13	Acc/Dec mode selection	0: linear Acc/Dec 1: S curve Acc/Dec	1	0	×
P0.14	Low speed time of S curve	10.0%~50.0% (Acc/Dec time) P0.14+P0.15<90%	0.1%	20.0%	○

P0.15	Linear time of S curve	10.0%~80.0% (Acc/Dec time) P0.14+P0.15<90%	0.1%	60.0%	○
P0.16	Acc/Dec time unit	0: second 1: minute	0	0	×
P0.17	Accerlate time 1	0.1~6000.0	0.1	10.0	○
P0.18	Decerlate time 1	0.1~6000.0	0.1	10.0	○
P0.19	High limit frequency	Lowest frequency ~highest output frequency P0.06	0.01Hz	50.00Hz	×
P0.20	Low limit frequency	0.00Hz~highest frequency	0.01Hz	0.00Hz	×
P0.21	Running mode of lowest frequency	0: running at lowest frequency 1: stop	1	0	×
P0.22	V/F curve setting	0: constant torque curve 1: torque-reducing curve 1 (1.2 powers) 2: torque-reducing curve 2 (1.7 powers) 3: torque-reducing curve 3 (2.0 powers) 4: multi-segment V/F curves	1	0	×
P0.23	V/F frequency value P1	0.00~P0.25	0.01Hz	0.00Hz	×
P0.24	V/F voltage value V1	0~ P0.26	0.1%	0.0%	×
P0.25	V/F frequency value P2	P0.23 ~ P0.27	0.01Hz	0.00Hz	×
P0.26	V/F voltage value V2	P0.24 ~ P0.28	0.1%	0.0%	×
P0.27	V/F frequency value P3	P0.25 ~ P0.07 basic running frequency	0.01Hz	0.00Hz	×
P0.28	V/F voltage value V3	P0.26 ~ 100.0%	0.1%	0.0%	×

2. Frequency parameter (Group P1)

Group P1: reference frequency parameter					
Parameter	Name	Setting range	Minmum unit	Default setting	Change
P1.00	Time constant of analog filter	0.01~30.00s	0.01s	0.20s	○
P1.01	The gain of VI channel	0.01~9.99	0.01	1.00	○
P1.02	min setting value of VI	0.00~P1.04	0.01V	0.00V	○
P1.03	Frequency of the min setting of VI	0.00~highest frequency	0.01Hz	0.00Hz	○
P1.04	Max setting of VI	P1.04~10.00V	0.01V	10.00V	○
P1.05	Frequency of the max setting of VI	0.00~highest frequency	0.01Hz	50.00Hz	○
P1.06	The gain of CI channel	0.01~ 9.99	0.01	1.00	○
P1.07	Min setting of CI	0.00~ P1.09	0.01V	0.00V	○
P1.08	Frequency of the min setting of CI	0.00~highest frequency	0.01Hz	0.00Hz	○

P1.09	Max setting of CI	P1.07 ~10.00V	0.01V	10.00V	○
P1.10	Frequency of the max setting of CI	0.00~highest frequency	0.01Hz	50.00Hz	○
P1.11	Max input pulse frequency of PULSE	0.1~20.0K	0.1K	10.0K	○
P1.12	Min setting of PULSE	0.0~P1.14 (Max setting of PULSE)	0.1K	0.1K	○
P1.13	Frequency of the min setting of PULSE	0.00~highest frequency	0.01Hz	0.00Hz	○
P1.14	Max setting of PULSE	P1.12 (Min setting of PULSE) ~ P1.11 (Max input frequency)	0.1K	10.0K	○
P1.15	Frequency of the max setting of PULSE	0.00~highest frequency	0.01Hz	50.00Hz	○
P1.16	Input mode of CI	0: 4~20mA 1: 0~10V	-	0	○

3. Starting and Braking Parameters (Group P2)

Group P2: Starting and Braking Parameters					
Parameter	Name	Range	Minmum unit	Factory setting	Change
P2.00	Starting mode	0: Start from the starting frequency 1: Brake first and then start from the starting frequency 2: detect current speed then startup	1	0	×
P2.01	Starting frequency	0.20~20.00Hz	0.01Hz	0.50Hz	○
P2.02	Holding time of starting frequency	0.0~30.0s	0.1s	0.0s	○
P2.03	DC brake current when startup	0.0~80.0%	0.1%	0%	○
P2.04	DC brake time when startup	0.0~60.0s	0.1s	0.0s	○
P2.05	Stopping mode	0: Decelerate 1: Free stop 2: Decelerate + DC brake	1	0	×
P2.06	DC brake startup frequency when stop	0.0~15.00Hz	0.0Hz	3.00Hz	○
P2.07	DC brake time when stop	0.0~60.0s	0.1s	0.0s	○
P2.08	DC brake current when stop	0.0~80.0%	0.1%	0.0%	○

4. Auxiliary running parameters (Group P3)

Group P3: Auxiliary running parameters					
Parameter	Name	Range	Minmum unit	Factory setting	Change
P3.00	Combination of frequency input	0: VI+CI 1: VI-CI 2: External pulse + VI+ Increase/Decrease key 3: External pulse - VI- Increase/Decrease key 4: External pulse + CI 5: External pulse - CI 6: RS485 + VI+ Increase/Decrease key 7: RS485 - VI- Increase/Decrease Key 8: RS485 + CI+ Increase/Decrease key 9: RS485 - CI- Increase/Decrease key 10: RS485 + CI+ External pulse 11: RS485 - CI- External pulse 12: RS485 + VI+ External pulse 13: RS485 - VI- External pulse 14: VI+CI+ Increase/Decrease key + Digital setting 15: VI+CI- Increase/Decrease key + Digital setting 16: MAX (VI, CI) 17: MIN (VI, CI) 18: MAX (VI, CI, PULSE) 19: MIN (VI, CI, PULSE) 20: VI, CI none-zero value is valid, VI is priority	1	0	×
P3.01	Parameter initialization Lock	Lowest bit: 0: All parameters can be modified 1: Only P3.01 can be modified 2: Only P0.02 and P3.01 can be modified ten bit: 0: disabled 1: Restore to default setting 2: Clear fault record	1	00	×
P3.02	Parameter copy	0: disabled 1: parameter upload 2: parameter download Note: Function is still in developing	1	0	×
P3.03	Auto energy-saving func-	0: disabled	1	0	×

	tion	1: Enabled			
P3.04	AVR function	0: disabled 1: enable all the time 2: Disabled when decelerating	1	0	×
P3.05	Slip frequency compensation	0~150%	1%	0%	×
P3.06	Jog frequency	0.10~50.00Hz	0.01Hz	5.00Hz	○
P3.07	Accelerate time of jog	0.1~60.0s	0.1s	5.0s	○
P3.08	Decelerate time of jog	0.1~60.0s	0.1s	5.0s	○
P3.09	Communication configuration	LED lowest bit: baud rate 0: 1200BPS 1: 2400BPS 2: 4800BPS 3: 9600BPS 4: 19200BPS 5: 38400BPS LED ten bit: data format 0: 1-7-2 foramt, no parity 1: 1-7-1 format, Odd 2: 1-7-1 format, Even 3: 1-8-2 format, None 4: 1-8-1 format, Odd 5: 1-8-1 format, Even 6: 1-8-1 format, None (When use Modbus-RTU communication mode, please select data mode 3~6) LED hundred bit: undefined	1	054	×
P3.10	Inverter address	0~248 0: broadcast address 248: inverter as the host address (function is developing)	1	1	×
P3.11	Communication timeout detect time	0.0~1000.0s 0.0: Detection disabled	0.1s	0.0s	×
P3.12	Inverter answer delay	0~1000ms	1	5ms	×
P3.13	Proportion of communication frequency	0.01~1.00	0.01	1.00	×
P3.14	Accerlate time 2	0.1~6000.0	0.1	10.0	○
P3.15	Decerlate time 2	0.1~6000.0	0.1	10.0	○
P3.16	Accerlate time 3	0.1~6000.0	0.1	10.0	○
P3.17	Decerlate time 3	0.1~6000.0	0.1	10.0	○
P3.18	Accerlate time 4	0.1~6000.0	0.1	10.0	○
P3.19	Decerlate time 4	0.1~6000.0	0.1	10.0	○
P3.20	Accerlate time 5	0.1~6000.0	0.1	10.0	○
P3.21	Decerlate time 5	0.1~6000.0	0.1	10.0	○
P3.22	Accerlate time 6	0.1~6000.0	0.1	10.0	○
P3.23	Decerlate time 6	0.1~6000.0	0.1	10.0	○
P3.24	Accerlate time 7	0.1~6000.0	0.1	10.0	○

P3.25	Decerlate time 7	0.1~6000.0	0.1	10.0	○
P3.26	Multi-frequency 1	Min frequency~max frequency	0.01Hz	5.00Hz	○
P3.27	Multi-frequency 2	Min frequency~max frequency	0.01Hz	10.00Hz	○
P3.28	Multi-frequency 3	Min frequency~max frequency	0.01Hz	20.00Hz	○
P3.29	Multi-frequency 4	Min frequency~max frequency	0.01Hz	30.00Hz	○
P3.30	Multi-frequency 5	Min frequency~max frequency	0.01Hz	40.00Hz	○
P3.31	Multi-frequency 6	Min frequency~max frequency	0.01Hz	45.00Hz	○
P3.32	Multi-frequency 7	Min frequency~max frequency	0.01Hz	50.00Hz	○
P3.33	Jump frequency 1	0.00~500.00Hz	0.01Hz	0.00Hz	×
P3.34	Range of jump frequency 1	0.00~30.00Hz	0.01Hz	0.00Hz	×
P3.35	Jump frequency 2	0.00~500.00Hz	0.01Hz	0.00Hz	×
P3.36	Range of jump frequency 2	0.00~30.00Hz	0.01Hz	0.00Hz	×
P3.37	Jump frequency 3	0.00~500.00Hz	0.01Hz	0.00Hz	×
P3.38	Range of jump frequency 3	0.00~30.00Hz	0.01Hz	0.00Hz	×
P3.39	Set running time	0~65.535K hour	0.001K	0.000K	○
P3.40	Accumulate running time	0~65.535K hour	0.001K	0.000K	*
P3.41	Display parameters selection 1	0000~FFFF Lowest bit: b-09~b-12 Ten bit: b-13~b-16 Hundred bit: b-17~b-20 Thousand bit: b-21~b-24	1	0000	○
P3.42	Display parameters selection 2	0000~FFFF Lowest bit: b-25~b-28 Ten bit: b-29~b-32 Hundred bit: b-33~b-36 Thousand bit: b-37~b-40	1	0000	○
P3.43	Display parameters selection 3	0000~4040 Ten bit, lowest bit: stop displayed parameter selection Thousand bit, hundred bit: run displayed parameter selection	1	0001	○
P3.44	Display coefficient without unit	0.1~60.0	0.1	1.0	○
P3.45	JOG/REV shift control mode	0: Jog running 1: reverse running	1	0	×

5. Function parameters of terminal (Group P4)

Group P4: Function Parameters of Teriminal

Parameter	Name	Range	Minnum unit	Factory setting	Change
P4.00	Function selection of input terminal X1	0: Control terminal is idle 1: Multi-speed control terminal 1 2: Multi-speed control	1	1	×

		terminal 2 3: Multi-speed control terminal 3 4: External forward jog input 5: External reverse jog input 6: Acc/Dec time terminal 1 7: Acc/Dec time terminal 2 8: Acc/Dec time terminal 3 9: 3-wire operation control 10: Free stop (FRS) 11: External stop command 12: DC brake input command DB 13: Inverter running prohibition 14: Frequency up (UP) 15: Frequency down (DOWN) 16: Acc/Dec prohibition 17: External reset (clear fault) 18: External fault signal (normal open) 19: Frequency setting channel 1 20: Frequency setting channel 2 21: Frequency setting channel 3 22: command switch to terminal 23: running command channel 1 24: running command channel 2 25: swing frequency selection 26: Reset swing frequency state 27: Close-loop disabled 28: simple PLC pause command 29: PLC disabled 30: Reset PLC stopping status 31: Frequency switch to CI 32: Counter trigger signal input			
--	--	---	--	--	--

		33: Counter reset input 34: External interrupt input 35: Pulse frequency input (only valid for X6) 36: Actual length reset input			
P4.01	Function selection of input terminal X2	Ditto	1	2	×
P4.02	Function selection of input terminal X3	Ditto	1	3	×
P4.03	Function selection of input terminal X4	Ditto	1	10	×
P4.04	Function selection of input terminal X5	Ditto	1	17	×
P4.05	Function selection of input terminal X6	Ditto	1	18	×
P4.06	Function selection of input terminal X7 FWD	Ditto	1	0	×
P4.07	Function selection of input terminal X8 REV	Ditto	1	0	×
P4.08	FWD/REV Operation mode selection	0: 2-wire control mode 1 1: 2-wire control mode 2 2: 3-wire control mode 1 3: 3-wire control mode 2	1	0	×
P4.09	UP/DOWN speed	0.01—99.99Hz/s	0.01	1.00Hz/s	○
P4.10	Bi-direction open-collector output terminal OC	0: Inverter running (RUN) 1: Frequency arriving sig- nal (FAR) 2: Frequency level detec- tion (FDT1) 3: Frequency level detec- tion (FDT2) 4: Overload pre-alarm (OL) 5: Inverter under voltage blockade and stop (LU) 6: External fault stop (EXT) 7: Output frequency arrive upper limit (FH) 8: Output frequency arrive lower limit (FL) 9: Inverter zero speed run- ning 10: Simple PLC running finished 11: PLC one period run- ning is completed 12:reach the setting count value	1	0	×

		13: Mid counting value arrived 14: Inverter running preparation is finished (RDY) 15: Inverter fault 16: Running with start frequency 17: DC brake when startup 18: brake when stop 19: High and low limit of swing frequency 20: set running time arrived			
P4.11	Relay output selector	Ditto	1	15	×
P4.12	Detecting range of frequency arrived (FAR)	0.00~50.00Hz	0.01Hz	5.00Hz	○
P4.13	FDT1 (frequency) voltage	0.00~upper limit of frequency	0.01Hz	10.00Hz	○
P4.14	FDT1 lag	0.00~50.00Hz	0.01Hz	1.00Hz	○
P4.15	FDT2 (frequency) voltage	0.00~upper limit of frequency	0.01Hz	10.00Hz	○
P4.16	FDT2 lag	0.00~50.00Hz	0.01Hz	1.00Hz	○
P4.17	Analog output (AO)	0: Output frequency (0~max frequency) 1: Output current (0~2 times of rated current) 2: Output voltage (0~1.2 inverter rated voltage) 3: Bus voltage (0~800V) 4: PID setting 5: PID feedback 6: VI (0~10V) 7: CI (0~10V/4~20mA)	1	0	○
P4.18	Analog output (AO) gain	0.50~2.00	0.01	1.00	○
P4.19	AO output mode	0: 4~20mA 1: 0~10V	-	1	○
P4.20	DO output terminal	0: Output frequency (0~upper limit frequency) 1: Output current (0~2 times motor rated current) 2: Output voltage (0~1.2 inverter rated voltage) 3: Bus voltage (0~800V) 4: PID setting 5: PID feedback 6: VI (0~10V) 7: CI (0~10V/4~20mA) 100: inverter is running (RUN)	1	0	○

		101: frequency reach signal (FAR) 102: frequency level detect signal (FDT1) 103: frequency level detect signal (FDT2) 104: overload pre-alarm (OL) 105: inverter under voltage blockade and stop (LU) 106: external error stop (EXT) 107: output frequency reach upper limit (FH) 108: output frequency reach lower limit (FL) 109: inverter zero-speed running 100: simple PLC running is completed 111: PLC complete one period running 112: reach the setting count value 113: reach the middle count value 114: inverter running preparation (RDY) 115: inverter error 116: run with startup frequency 117: DC brake when startup 118: brake when stop 119: swing frequency up/down limit 120: reach the preset running time			
P4.21	DO max pulse output frequency	0.1K~20.0K (Max: 20KHz)	0.1KHz	10.0KHz	○
P4.22	preset counting value arrived	P4.23~9999	1	0	○
P4.23	Mid counting value arrived	0~P4.22	1	0	○
P4.24	Overload pre-alarm detection level	20%~200%	1	130%	○
P4.25	Delay time of over load pre-alarm	0.0~20.0s	0.1s	5.0s	○

6. Protective function parameters (Group P5)

Group P5: Protective function parameters					
Parameter	Name	Range	Minmum unit	Default setting	Change
P5.00	Motor overload protection mode selection	0: Inverter lock the output 1: Disabled	1	0	×
P5.01	Motor overload protection coefficient	20~120%	1	100%	×
P5.02	Over-voltage speed loss selection	0: Disabled 1: Enabled	1	1	×
P5.03	Speed loss over-voltage point	380V: 120~150% 220V: 110~130%	1%	140% 120%	○
P5.04	Auto current limiting	110%~200%	1%	150%	×
P5.05	Frequeny decrease rate when current limiting	0.00~99.99Hz/s	0.01Hz/s	10.00Hz/s	○
P5.06	Auto current limiting selection	0: constant speed invalid 1: constant speed valid Note: Acc/Dec is valid	1	1	×
P5.07	Restart after power off	0: no action 1: action	1	0	×
P5.08	wait time of restart after power off	0.0~10.0s	0.1s	0.5s	×
P5.09	Error auto recover times	0~10 0: No auto recover function (Note: overload and overheat have no recovery function)	1	0	×
P5.10	Error auto recover interval time	0.5~20.0s	0.1s	5.0s	×

7. Fault recording parameter (Group P6)

Group P6: Fault recording parameter					
Parameter	Name	Description	Minmun unit	Default setting	Change
P6.00	Previous fault record	Previous fault record	1	0	*
P6.01	Output frequency of previous fault	Output frequency of previous fault record	0.01Hz	0	*
P6.02	Setting frequency of previous fault	Setting frequency of previous fault record	0.01Hz	0	*
P6.03	Output current of previous fault	Output current of previous fault	0.1A	0	*
P6.04	Output voltage of previous fault	Output voltage of previous fault	1V	0	*
P6.05	DC bus voltage of previous fault	DC bus voltage of previous fault	1V	0	*
P6.06	Module temperature of previous fault	Module temperature of previous fault	10C	0	*

P6.07	First 2 times fault records	First 2 times fault records	1	0	*
P6.08	First 3 times fault records	First 3 times fault records	1	0	*
P6.09	First 4 times fault records	First 4 times fault records	1	0	*
P6.10	First 5 times fault records	First 5 times fault records	1	0	*
P6.11	First 6 times fault records	First 6 times fault records	1	0	*

8. Close-loop control parameters (Group P7)

Group P7: Close-loop control parameters					
Parameter	Name	Range	Minmum unit	Default setting	Change
P7.00	Close-loop function selection	0: Disabled 1: Enabled	1	0	×
P7.01	Channel selection	0: Digital input 1: VI (0~10V) analog voltage 2: CI analog	1	1	○
P7.02	Feedback channel selection	0: VI (0~10V) voltage input 1: CI analog input 2: VI+CI 3: VI-CI 4: Min {VI, CI} 5: Max {VI, CI}	1	1	○
P7.03	Appointetd channel filter	0.01~50.00s	0.01s	0.50s	○
P7.04	Feedback channel filter	0.01~50.00s	0.01s	0.50s	○
P7.05	Digital setting	0.00~10.00V	0.01V	0.00V	○
P7.06	Min setting value	0.0~Max P7.08	0.1%	0.0%	○
P7.07	Feedback value corresponding to min setting value	0.0~100.0%	0.1%	0.0%	○
P7.08	Max setting value	Min P7.06~100.0%	0.1%	100.0%	○
P7.09	Feedback value corresponding to max setting value	0.0~100.0%	0.1%	100.0%	○
P7.10	Proportional KP	0.000~9.999	0.001	0.050	○
P7.11	Integral KI	0.001~9.999	0.001	0.050	○
P7.12	Sampling cycle T	0.01~10.00s	0.01	1.00	○
P7.13	Limits of deviation	0.0~20.0%	1%	2.0%	○
P7.14	Close loop adjustment characteristic	0: Forward 1: Reverse Note: relationship between setting value and speed	1	0	×
P7.15	Integral adjustment selection	0: Stop integral adjustment when the frequency reaches upper limit or lower limit 1: Continue the integral adjustment when the frequency reaches high limit or lower limit	1	0	×
P7.16	Close loop preset frequency	0~upper limit of of frequency	0.01Hz	0.00Hz	○
P7.17	Holding time of close-loop preset frequency	0.0~250.0s	0.1s	0.1s	×
P7.18	Awakening threshold	0.00~500.00Hz	0.01Hz	0.01Hz	×
P7.19	backlash of zero-frequency	0.00~500.00Hz	0.01Hz	0.01Hz	×

9. Simple PLC operation parameters (Group P8)

Group P8: Simple PLC operation parameters					
Parameters	Name	Range	Minum unit	Default setting	Change
P8.00	Simple PLC operation mode selection	0000~1113 Lowest bit: mode selection 0: Disabled 1: Stop after single cycle 2: keep the final value after single cycle 3: continuous cycle Ten bit: PLC pause and restartup mode selection 0: Run again from stage 1 1: Continue running from the pause frequency Hundred bit: save PLC parameter when power off 0: Not saving 1: Save the frequency when power off Thousand bit: time unit of stage running 0: second 1: minute	1	0000	×
P8.01	Stage 1 setup	000~621 Lowest bit: frequency setup 0: Multi I (i=1~7) 1: Frequency P0.01 Ten bit: Operating direction selection 0: Run forward 1: Run reverse 2: Decided by operating instructions Hundred bit: Acc/Dec time selection 0: Acc/Dec time 1 1: Acc/Dec time 2 2: Acc/Dec time 3 3: Acc/Dec time 4 4: Acc/Dec time 5 5: Acc/Dec time 6 6: Acc/Dec time 7	1	000	○
P8.02	Operating time of stage 1	0.1~6000.0	0.1	10.0	○
P8.03	Stage 2 setup	000~621	1	000	○
P8.04	Operating time of stage 2	0.1~6000.0	0.1	10.0	○
P8.05	Stage 3 setup	000~621	1	000	○
P8.06	Operating time of stage 3	0.1~6000.0	0.1	10.0	○
P8.07	Stage 4 setup	000~621	1	000	○
P8.08	Operating time of stage 4	0.1~6000.0	0.1	10.0	○
P8.09	Stage 5 setup	000~621	1	000	○
P8.10	Operating time of stage 5	0.1~6000.0	0.1	10.0	○
P8.11	Stage 6 setup	000~621	1	000	○
P8.12	Operating time of stage 6	0.1~6000.0	0.1	10.0	○
P8.13	Stage 7 setup	000~621	1	000	○
P8.14	Operating time of stage 7	0.1~6000.0	0.1	10.0	○

10. Swing frequency and measurement functions parameters (Group 9)

Group P9: Swing frequency and measurement function parameters					
Parameters	Name	Range	Minnum unit	Default setting	Change
P9.00	Swing frequency selection	0: Disabled 1: Enabled	1	0	×
P9.01	Swing frequency mode	00~11 Lowest bit: input mode 0: Auto input mode 1: Manual input mode Ten bit: Amplitude control 0: Variable amplitude 1: Fixed amplitude	1	00	×
P9.02	Preset swing frequency	0.00~500.00Hz	0.01Hz	0.00Hz	○
P9.03	Waiting time of preset swing frequency	0.0~3600.0s	0.1s	0.0s	○
P9.04	Swing frequency amplitude	0.0~50.0%	0.1%	0.0%	○
P9.05	Jitter frequency	0.0~50.0% (with reference to P9.04)	0.1%	0.0%	○
P9.06	Swing frequency cycle	0.1~999.9s	0.1s	10.0s	○
P9.07	Rising time of trangle wave	0.0~98.0% (with)	0.1%	50.0%	○
P9.08	Setting length	0.000 ~ 65.535(km)	0.001km	0.000km	○
P9.09	Actual length	0.0~65.535km (Saving at power off)	0.001km	0.000km	○
P9.10	Rates of length	0.001~30.000	0.001	1.000	○
P9.11	Correction coefficient of length	0.001~1.000	0.001	1.000	○
P9.12	Perimeter of shaft	0.01~100.00cm	0.01cm	10.00cm	○
P9.13	Number of pulses per revolution	1~9999	1	1	○

11. Vector control parameters

(Group PA)

Group PA: Vector Control Parameters					
Parameter	Name	Range	Minnum unit	Factory setting	Change
PA.00	Motor auto-tune	0: No tune 1: auto tune	1	0	×
PA.01	Rated voltage of motor	0~400V	1	Dependent on inverter's model	×
PA.02	Rated current of motor	0.01~500.00A	0.01A	Dependent on inverter's model	×
PA.03	Rated frequency of motor	1~99Hz	1Hz	Dependent on inverter's model	×
PA.04	Rated speed of motor	1~9999 r/min	1r/min	Dependent on inverter's model	×

PA.05	Poles of motor	2~48	1	Dependent on inverter's model	×
PA.06	Stator inductance of motor	0.1~5000.0mH	0.1mH	Dependent on inverter's model	×
PA.07	Rotor inductance of motor	0.1~5000.0mH	0.1mH	Dependent on inverter's model	×
PA.08	Mutual induction of stator and rotor	0.1~5000.0mH	0.1mH	Dependent on inverter's model	×
PA.09	Stator resistance of motor	0.001~50.000Ω	0.001Ω	Dependent on inverter's model	×
PA.10	Rotor resistance of motor	0.001~50.000Ω	0.001Ω	Dependent on inverter's model	×
PA.11	Over current protection coefficient of torque current	0~15	1	15	×
PA.12	Proportion adjustment coefficient of speed loop	50~120	1	85	×
PA.13	Integral adjustment coefficient of speed loop	100~500	1	360	×
PA.14	Vector torque boost	100~150	1	80	×
PA.15	Reversed	0	0	0	×
PA.16	Reversed	1~5	1	4	×
PA.17	Excitation	100~150	1	100	×
PA.18	Slip compensation factor	150	1	150	×
PA.19	Reversed	0~2	1	0	

12. Special Application parameters (Group PB)

Group PB: Special Application parameters					
Parameter	Name	Range	Minmum unit	Default setting	Change
PB.00	Jog frequency source	0~4 0: P3.06 1: Panel potentiometer 2: P0.02 3: VI 4: CI	0	0	○
PB.01	selection of forward/reverse dead time	0: Dead time is enabled (Min 0.1s) 1: dead time can be set to 0 (set P0.05=0.0s, P0.20≥0.5Hz)	1	0	○
PB.02	Inverter type selection	0: G type(normal) 1: P type(wind machine, water pump, power improves 1 level) Note:if set to 1, P0.22 must set to 3	1	0	×
PB.03	Short the run terminal before power on and set the run mode	0: after inverter is power on, run immediately 1: after inverter is power on, cut off the terminal and connect again then run	1	1	×

13. Default setting (Group PF)

Group PP: Default Setting					
Parameter	Name	Range	Minmum unit	Default setting	Change
PF.00	Default password	-	-	-	*
PF.01	User's password	0: No password 0001—9999: passwor protection	1	0000	○
PF.02	Software version	-	-	-	*
PF.03~PF.10	Reversed	-	-	-	*

14. B Monitor function parameters

B-Monitor function parameters					
Code	Name	Description	Minmum unit	Factory setting	Change
b-00	Output frequency	Present output frequency	0.01Hz		*
b-01	Setting frequency	Present setting frequency	0.01Hz		*
b-02	Output voltage	Valid value of present output voltage	1V		*
b-03	Output current	Valid value of present output current	0.1A		*
b-04	Bus voltage	Present DC bus voltage	1V		*
b-05	Module temperature	IGBT radiator temperature	10C		*
b-06	Motor speed	Present motor speed	1r/min		*
b-07	Operating time	Continuous operating time of inverter	1 hour		*
b-08	Input/output terminal status	Digital input/output terminal status	---		*
b-09	Analog input VI	Value of analog input VI	0.01V		*
b-10	Analog input CI	Value of analog input CI	0.01V		*
b-11	External pulse input	Input value of external pulse width	1ms		*
b-12	Inverter rated current	Inverter rated current	0.1A		*
b-13	Inverter rated voltage	Inverter rated voltage	1V		*
b-14	no unit dispaly	no unit dispaly	1		*
b-15	Inverter power class	Inverter power class	-		*
b-16	Display present counter value	Display present counter value	-		*
b-17	Reversed	-	-		*
.....	Reversed	-	-		*
b-40	Reversed	-	-		*

Note: The relationship of monitor parameter input/output terminals and their status are shown below:

“ / ” means invalid (light is off), “ / ” means valid (light is on)

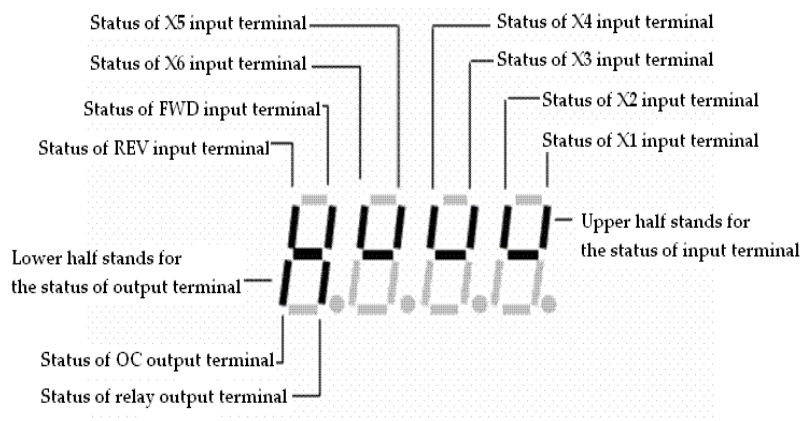

4-2. Function code description

4-2-1. Basic operating function parameters (Group P0)

P0.00	Control mode selection	Range: 0~1	0
-------	------------------------	------------	---

0: V/F control

1: Open loop vector control

P0.01	Frequency setting channel selection	Range: 1~8	0
-------	-------------------------------------	------------	---

0: Panel analog potentiometer setting

1: ▲ and ▼ keys on the panel

You can set the reference frequency via ▲ and ▼ keys on the panel.

2: Keyboard digital setting

Initial frequency is the value of P0.02, change the value in P0.02 by operate panel.

3: Terminal UP/DOWN

Initial frequency is the value of P0.02, set the frequency via terminal UP/DOWN.

4: Serial port (remote control)

Initial frequency is the value of P0.02, set the frequency via serial port.

5: VI analog input (VI—GND)

The frequency is set by analog voltage input via terminal VI, the input voltage range is DC 0~10V. The relationship between frequency and VI is decided by parameters P1.00~P1.05.

6: CI analog input (CI—GND)

The frequency is set by analog voltage/current of terminal CI and the input range is DC 0~10V (jumper JP3 select “V” side), DC: 4~20mA (jumper JP3 select “A” side). The relationship between frequency and CI input is decided by parameter P1.06~P1.10.

7: Pulse input (PLUSE)

The frequency is set by pulse input via pulse terminal (can only be input via terminal X6). The relationship between frequency and PLUSE input is decided by parameters P1.11~P1.15.

8: Combination



Please refer to P3.00, set the frequency via the combination of each channel.

P0.02	Digital frequency setting	Range: Upper limit of frequency~lower limit of frequency	50.00Hz
-------	---------------------------	--	---------

When the frequency is set in digital mode (P0.01=1, 2, 3, 4), the value of P0.02 is the inverter's initial frequency.

P0.03	Running command channel selection	Range: 0, 1, 2	0
-------	-----------------------------------	----------------	---

0: Panel control

Use    to stop, start the inverter.

1: Terminal control

Use external terminal FWD, REV, X1~X6 to start or stop the inverter.

2: Serial port control

To start or stop the inverter via RS485 port.

Note: The control modes can be set by P0.03, please be careful to use this method during operating.

P0.04	Set running direction	Range: 00~11	00
-------	-----------------------	--------------	----

The lowest bit of this parameter is valid only for panel jog command channel.

Lowest bit of LED:

0: Jog forward in panel control mode

1: Jog reverse in panel control mode

Ten bit of LED:

0: Reverse running is permissible.

1: Reverse running is suppressed. The inverter will stop output when there is reverse command.

P0.05	Run forward/reverse dead time	Range: 0.0~120.0s	0.1s
-------	-------------------------------	-------------------	------

It is the transition time when output zero frequency during the inverter switch from forward to reverse or reverse to forward, as shown in Fig.4-1 t_1 .

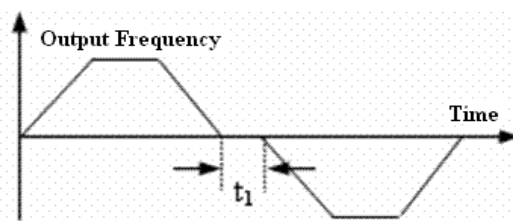

Fig. 4-1 Run forward/reverse dead time

P0.06	Max output frequency	Range: 50.00Hz~500.0Hz	50.00Hz
P0.07	Basic running frequency	Range: 1.00Hz~500.00Hz	50.00Hz
P0.08	Max output voltage	Range: 1~480V	Rated

The max output frequency is the highest frequency of the inverter, as shown in Fig.4-2.

Basic running frequency is the lowest frequency when the inverter output the highest voltage and it is usually the rated frequency of the motor, as shown in Fig4-2 FB.

The max output voltage is the relevant output voltage when the inverter output basic running frequency and it is usually the rated voltage of the motor, as shown in Fig.4-2 V_{max} .

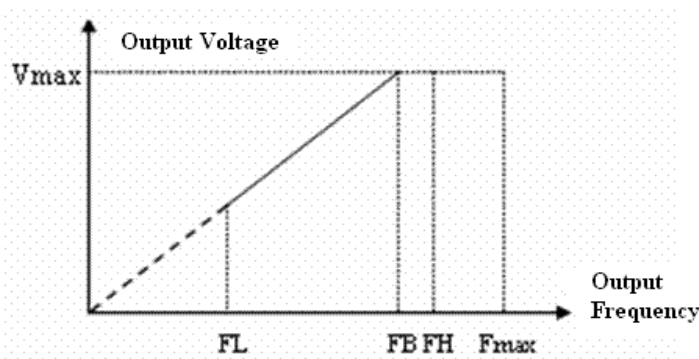
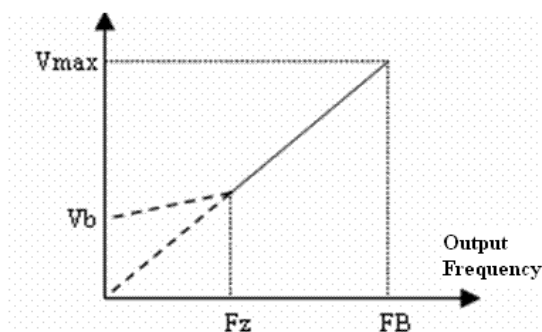

Fig. 4-2 Characteristic parameter

FH(highest frequency), FL(lowest frequency) are defined by P0.19 and P0.20 .

P0.09	Torque boost	Range: 0.0%~30.0%	2.0%
-------	--------------	-------------------	------

Improve inverter low frequency torque characteristics, boost-compensate the output voltage.



Vb : Manual torque boost voltage Vmax : Max output voltage
 Fz : Cut-off frequency for torque boost FB : Basic running frequency

(a) Torque boost of constant torque curve

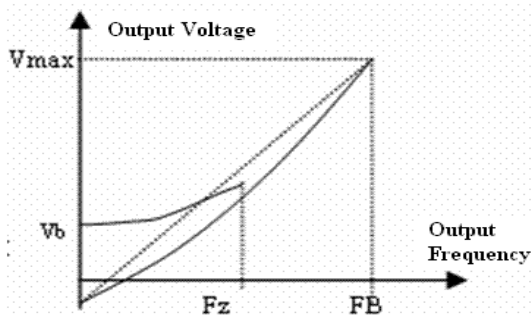

Vb : Manual torque boost voltage Vmax : Max output voltage
 Fz : Cut-off frequency of torque boost FB : Basic running frequency

(b) Torque boost of square torque curve

Fig. 4—3 Torque boost

P0.10	Cutoff frequency of torque boost	Range: 0.00Hz~Basic running frequency	25.00Hz
-------	----------------------------------	---------------------------------------	---------

This function defines the cut-off frequency of torque boost, as shown in Fig. 4-3 Fz. Then cut-off frequency is suitable for any V/F curve defined by P0.02.

P0.11	Torque boost mode	Range: 0, 1	0
-------	-------------------	-------------	---

0: Manual torque boost

Torque boost voltage is defined by parameter P0.09. The boost voltage is fixed while motor will be easily magnetism saturation with light load.

1: Auto torque boost

Torque boost voltage will change with the motor stator's current changes. The bigger the stator is, the higher the boost voltage.

$$\text{Boost Voltage} = \frac{P0.09}{100} \times \text{Motor's Rated Voltage} \times \frac{\text{Inverter's output current}}{2 \times \text{Inverter's rated current}}$$

P0.12	Carrier frequency	Range: 1.0K~14.0K	8.0K
--------------	--------------------------	--------------------------	-------------

The default carrier frequency below 3.7kW inverter is 5.0 kHz; it is 3.0 kHz for 5.5kW and larger inverters.

Carrier frequency will effects the motor’s noise and heat loss.The relationship among carier frequency, motor noise, leak current, and interference are shown below:

Carrier frequency	Decrease	Increase
Motor noise	↑	↓
Leakage current	↓	↑
disturbance	↓	↑

Note: (1) In order to achieve better performances, the ratio of carrier

Note: (1) to obtain the best control features, the ratio of carrier frequency and highest running frequency must more than 36.

(2) When the carrier frequency is low, the current display value may be error.

P0.13	Acc/Dec mode	Range: 0, 1	0
--------------	---------------------	--------------------	----------

0: Linear Accerlate/Decelerate mode

Output frequency increases or decreases as a constant slope, see Fig. 4-4.

1: S curve Accerlate/Decelerate mode

Output frequency increases or decreases as S-curve, see Fig.4-5.

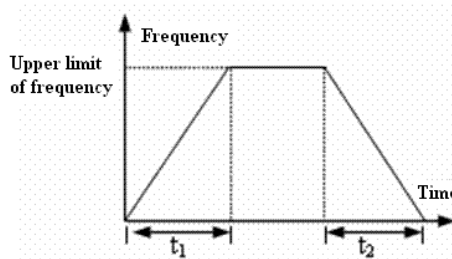

Fig.4-4 Linear Acc/Dec

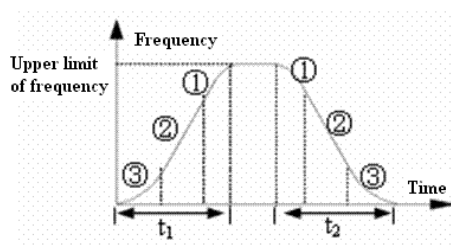

Fig.4-5 S-curve

P0.14	Low speed time of S curve	Range: 10.0%~50.0% (Acc/Dec time), P0.14+P0.15<90%	20.0%
P0.15	Linear time of S curve	Range: 10.0%~80.0% (Acc/Dec time), P0.14+P0.15<90%	60.0%

P0.14 and P0.15 are only valid when Acc/Dec mode is S curve Acc/Eec mode (P0.13 = 1) and P0.14+P0.15 < 90%.

Low speed time of S curve is shown in Fig.4-5 ③, the output frequency slope increases from 0.

Linear time of S curve is shown in Fig.4-5 ②, the output frequency slope is constant.

High speed time of S curve is shown in Fig.4-5 ①, the output frequency slope decreases to 0.

High speed time = 100% – P0.14 – P0.15.

Note: S curve Acc/Dec mode is suitable for the start/stop of elevator, conveying belt, conveying load and so on.

P0.16	Acc/Dec time unit	Range: 0, 1	0
-------	-------------------	-------------	---

This function defines Acc/Dec time unit

0: second

1: minute

Note: (1) This function is valid for all the Acc/Dec mode except jog running.

(2) Second unit is recommended.

P0.17	Acc time 1	Range: 0.1~6000.0	10.0
P0.18	Dec time 1	Range: 0.1~6000.0	10.0

Acc time is the time accelerating from 0 Hz to highest frequency, see t_1 in Fig.4-6; Dec time is the time decelerating from highest frequency to 0 Hz, see t_2 in Fig.4-6.

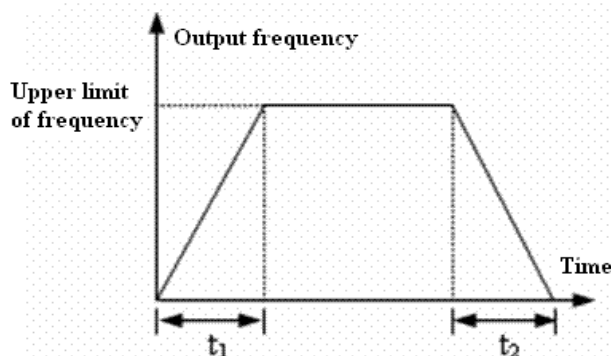

Fig.4-6 Acc/Dec time

Note: (1) This series inverter defines seven kinds of Acc/Dec time. Here only defines Acc/Dec time 1, Acc/Dec time 2~7 are defined in P3.14~P3.25.

(2) Define the Acc/Dcc time unit in P0.16 (minute, second, default is second).

P0.19	Highest frequency	Range: lowest frequency~max output frequency	50.00Hz
P0.20	Lowest frequency	Range: 0.00Hz~highest frequency	0.00HZ
P0.21	Lowest frequency running mode	Range: 0: run with lowest frequency 1: stop	0

P0.19 and P0.20 define the upper and lower frequency, see Fig.4-2 FH(highest frequency) and FL(lowest frequency).

If the actual setting frequency is lower than lowest frequency, inverter will decelerate the output frequency. When it reach the lowest frequency, if the lowest frequency running mode is 0, inverter will run with lowest frequency. If the lowest frequency running mode is 1, inverter will decrease the output frequency to 0.

P0.22	V/F curve setting	Range: 0~4	0
P0.23	V/F frequency value F1	Range: 0.00~P0.25	0.00Hz
P0.24	V/F voltage valueV1	Range: 0~P0.26	0.0%
P0.25	V/F frequency value F2	Range: P0.23~P0.27	0.00Hz
P0.26	V/F voltage value V2	Range: P0.24~P0.28	0.0%
P0.27	V/F frequency value F3	Range: P0.25~P0.07 basic running frequency	0.00Hz
P0.28	V/F voltage value V3	Range: P0.26~ 100.0%	0.0%

This group of parameters defines the flexible V/F setting modes of this inverter to satisfy the requirement of different loads. Four fixed curves and one user-defined curve can be selected in P0.22.

P0.22=0, V/F curve is constant torque curve, as shown in Fig.4-7 curve 0.

P0.22=1, V/F curve is 1.2 powers torque-reducing curve, as shown in Fig. 4-7 curve 1.

P0.22=2, V/Fcurve is 1.7 powers torque-reducing curve, as shown in Fig.4-7 curve 2.

P0.22=3, V/Fcurve is 2.0 powers torque-reducing curve, as shown in Fig.4-7 curve 3.

To obtain the best energy-saving effect, user can select V/F curve 1, 2, 3 for fan, pump load.

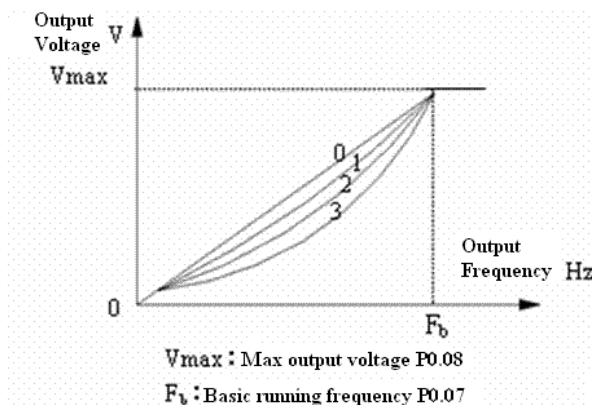

Fig.4-7 V/F curve

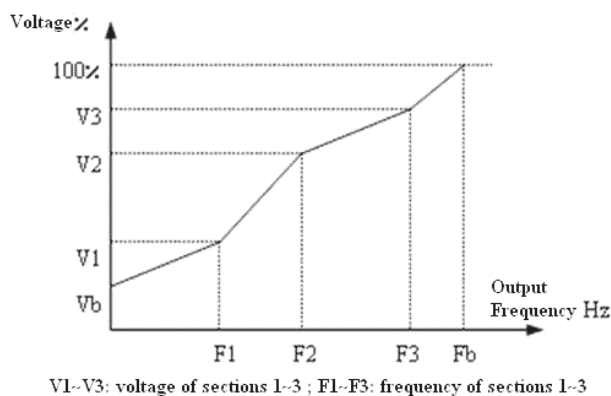

Fig. 4-8 User-defined V/F curve

When P0.22 = 4, you can define V/F curve via modifying (V₁, F₁), (V₂, F₂), (V₃, F₃) to satisfy the special load requirement, as shown in Fig.4-8. Torque boost is suitable for user-defined V/F curve. In Fig.4-8.

$$V_b = \text{Torque boost (P0.09)} \times V_1$$

4-2-2. Parameters of frequency setting (Group P1)

P1.00	Time constant of analog filter	Range: 0.01~30.00s	0.20s
-------	--------------------------------	--------------------	-------

The inverters filter time for sample value when set the frequency by analog channel. If the wiring is too long or noise is too serious, increase this parameter to improve the frequency stability. The longer the filter time, the stronger the noise immunity ability. However, the reponse will be slower.

P1.01	The gain of VI channel	Range: 0.01~9.99	1.00
P1.02	Min setting of VI	Range: 0.00~P1.04	0.00V
P1.03	Frequency of VI min setting	Range: 0.00~upper limit of frequency	0.00Hz
P1.04	Max setting of VI	Range: P1.04~10.00V	10.00V
P1.05	Frequency of VI max setting	Range: 0.00~upper limit of frequency	50.00Hz
P1.06	Gain of CI channel	Range: 0.01~ 9.99	1.00
P1.07	Min setting of CI	Range: 0.00~ P1.09	0.00V
P1.08	Frequency of CI min setting	Range: 0.00~upper limit of frequency	0.00Hz
P1.09	Max setting of CI	Range: P1.07 ~10.00V	10.00V
P1.10	Frequency of CI max setting	Range: 0.00~upper limit of frequency	50.00Hz
P1.11	Max input pulse frequency of PULSE	Range: 0.1~20.0K	10.0K
P1.12	Min setting of PULSE	Range: 0.0~P1.14	0.1K

P1.13	Frequency of PULSE min setting	Range: 0.00~upper limit of frequency	0.00Hz
P1.14	Max setting of PULSE	Range: P1.12~P1.11	10.0K
P1.15	Frequency of PULSE max setting	Range: 0.00~upper limit of frequency	50.00Hz
P1.16	Input mode of CI	Range: 0, 1	0

When VI, CI and PULSE are selected as open loop frequency setting channel, the relationship between setting and the present frequency is shown below:

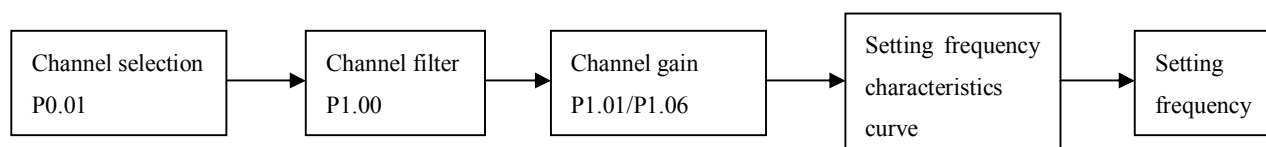

The relationship between VI and setting frequency:

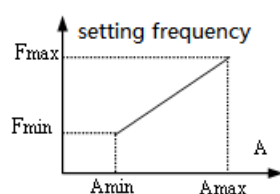

(1) positive function

A: VI setting Amin: min setting
Amax: max setting

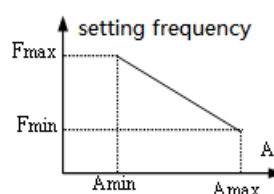

(2) negative function

Fmin: frequency of min setting
Fmax: frequency of max setting

The relationship between CI and setting frequency:

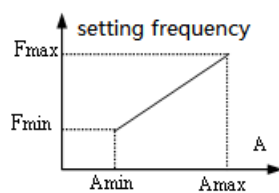

(1) positive function

A: CI setting Amin: min setting
Amax: max setting

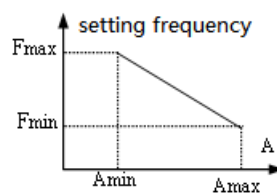

(2) negative function

Fmin: frequency of min setting
Fmax: frequency of max setting

The relationship between PULSE and setting frequency:

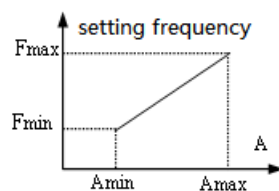

(1) positive function

A: PULSE setting Amin: min setting
Amax: max setting

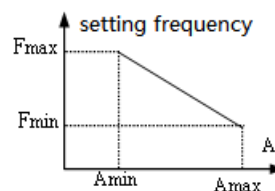

(2) negative function

Fmin: frequency of min setting
Fmax: frequency of max setting

4-2-3. Starting and braking parameters (Group P2)

P2.00	Starting mode	Range: 0, 1, 2	0
-------	---------------	----------------	---

0: Start from the starting frequency

Inverter starts at the starting frequency (P2.01) within the lasting time of starting frequency (P2.02).

1: Brake first and then start from the starting frequency

Brake with DC braking current (P2.03) within braking time (P2.04) and then start at starting frequency.

2: Track the speed then start

When P2.00=2, it is valid for repowering after instantaneous power off or restarting after external fault. As shown in Fig.4-9.

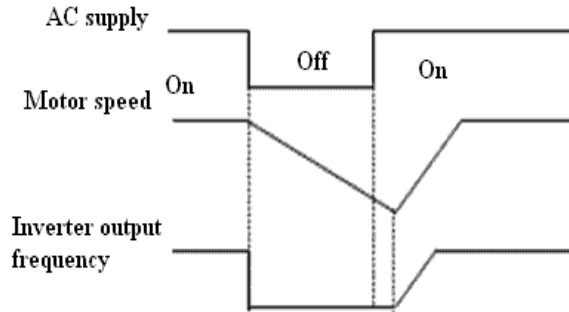

Fig.4-9 Speed track then start

- Note:** (1) Starting mode 0: It is recommended for general application or when the inverter drives synchronous motor.
 (2) Starting mode 1: It is suitable for small inertial load that motor no driving but there is forward or reverse rotation, and it is not recommended for big inertial load.
 (3) Starting mode 2: It is suitable for motor startin during free stop or restarting after instantaneous power off.

P2.01	Starting frequency	Range: 0.20~20.00Hz	0.50 Hz
P2.02	Lasting time of starting frequency	Range: 0.0~30.0S	0.0S

Starting frequency points to the initial frequency when inverter starts; see Fig.4-10 F_s . Lasting time of starting frequency points to the time while inverter is running at the starting frequency, see Fig.4-10 t_1 .

Note: Starting frequency is not limited by the lowest frequency.

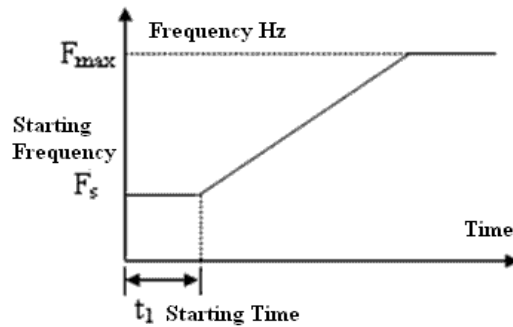

Fig.4-10 Starting frequency and starting time

P2.03	DC brake current when starting	Range: 0~80(%)	0(%)
P2.04	DC brake time when starting	Range: 0.0~60.0s	0.0s

When P2.00 =1, P2.03 and P2.04 are valid, as shown in Fig. 4-11. The setting of DC brake current is the percentage of rated current.

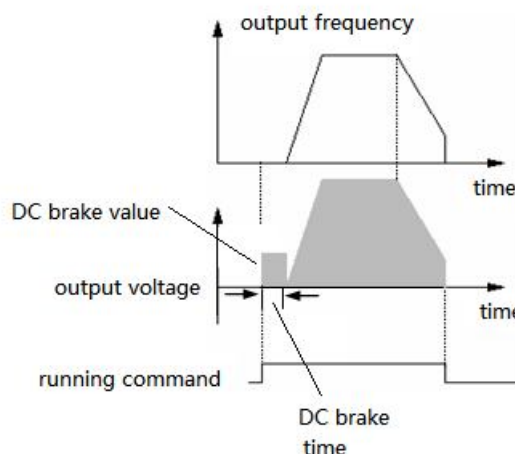

Fig.4-11 Starting mode 1

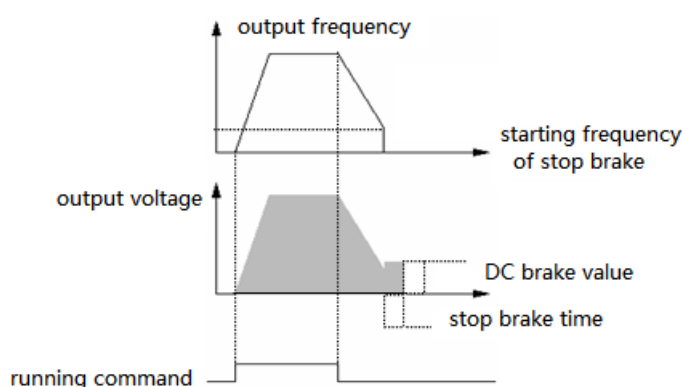

Fig. 4-12 Decelerate stop+DC brake

P2.05	Stopping mode	Range: 0,1,2	0
-------	---------------	--------------	---

0: Decelerate stop

After receiving the stopping command, the inverter reduces its output frequency within decelerate time and stops when the frequency becomes 0.

1: Free stop

After receiving the stopping command, the inverter stops immediately and the motor stops according to mechanical inertia.

2: Decelerate stop+DC brake

After receiving the stopping command, the inverter reduces its output frequency according to decelerate time and then start to DC brake when reach P2.06 (stop brake starting frequency).

P2.06	Starting frequency of stop brake	Range: 0.0~15.00Hz	3.00Hz
P2.07	DC brake time when stopping	Range: 0.0~60.0s	0.0s
P2.08	DC brake current when stopping	Range: 0~80 (%)	0(%)

P2.08 is the percentage value of DC brake current and inverter rated current. There is no DC braking when the braking time is 0.0, as shown in Fig.4-12.

4-2-4. Auxiliary running parameters (Group P3)

P3.00	Combination of frequency setting channel	Range: 0~20	0
-------	--	-------------	---

When P0.01 (Frequency setting channel) = 8, set the frequency setting channel combination via P3.00.

- 0: VI+CI
- 1: VI-CI
- 2: External pulse +VI+Increase/Decrease key
- 3: External pulse-VI-Increase/Decrease key
- 4: External pulse+CI
- 5: External pulse-CI
- 6: RS485+VI+Increase/Decrease key
- 7: RS485-VI-Increase/Decrease key
- 8: RS485+CI+Increase/Decrease key
- 9: RS485-CI-Increase/Decrease key
- 10: RS485+CI+External pulse
- 11: RS485-CI-External pulse
- 12: RS485+VI+External pulse
- 13: RS485-VI-External pulse
- 14: VI+CI+Increase/Decrease key+Digital setting P0.02
- 15: VI+CI-Increase/Decrease key+Digital setting P0.02
- 16: MAX (VI, CI)
- 17: MIN (VI, CI)
- 18: MAX (VI, CI, PLUSE)
- 19: MIN (VI, CI, PLUSE)
- 20: VI, CI is avalid, VI is priority

P3.01	Parameter initialization lock	Range: lowest bit 0~2, ten bit ~2	00
--------------	--------------------------------------	--	-----------

LED lowest bit:

- 0: All the parameters can be modified.
- 1: other parameters cannot be modified except this parameter.
- 2: Only P0.02 and P3.01 can be modified.

LED ten bit:

- 0: invalid
- 1: Restore to default setting
- 2: Clear fault record

Note: (1) The default setting of P3.01 is 0 and allows all the parameters to be modified. Please set it to 0 before you want to modify function code. If it is need to protect the parameters, please set this parameter to required protection level.

(2) P3.01 will be changed to 0 automatically after restoring to default setting.

P3.02	Parameter copy (this function is developing)	Range: 0, 1, 2	0
--------------	---	-----------------------	----------

0: Disabled

1: Parameter upload: Upload the parameters from inverter to remote operation panel.

2: Parameter download: Download the parameters from remote operation panel to inverter.

Note: This function is still in developing.

P3.03	Auto energy-saving running	Range: 0, 1	0
--------------	-----------------------------------	--------------------	----------

0: Disabled

1: Enabled

Inverter can saves the energy through detecting the load current; adjust output voltage when motor has no load or light load running. This function is used to the situation of stable load and speed.

P3.04	AVR funciton	Range: 0, 1, 2	0
--------------	---------------------	-----------------------	----------

AVR is auto voltage regulation. When the input voltage of inverter fluctuates, AVR function can keep it stable.

When decelerating stop, if AVR is disabled, the decelerate time is short and the running current is large; if AVR is enabled, the motor will stable decelerate, the running current is small and the decelerate time is longer.

0: Disabled

1: Enabled

2: Disabled in Dec process

P3.05	slip frequency compensation	Range: 0~150(%)	0(%)
-------	-----------------------------	-----------------	------

This function can make suitable regulation for inverter's output frequency according to the load changing, and control the speed at a certain value by dynamic compensating the slip frequency of asynchronous motor. If auto-torque boost function is used together, better low speed torque characteristic can be obtained. As shown in Fig.4-13.

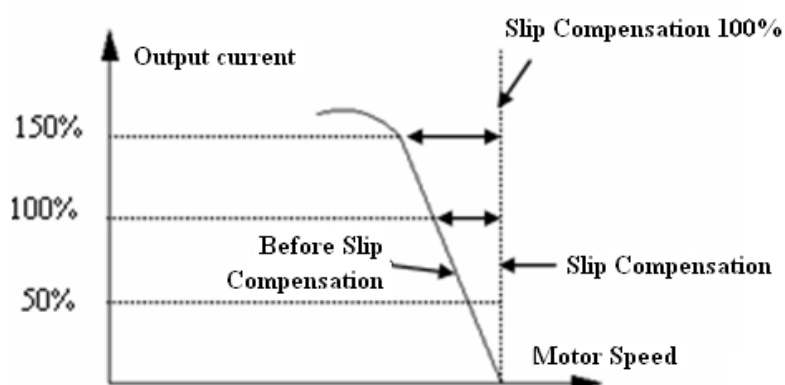

Fig.4-13 Slip Compensation

P3.06	Jog operating frequency	Range: 0.10~50.00Hz	5.00Hz
P3.07	Accerlate time of jog operation	Range: 0.1~60.0s	5.0s
P3.08	Dec time of jog operation	Range: 0.1~60.0s	5.0s

Jog operating frequency has the highest priority. No matter what status the inverter is, once there is a jog operating command input, the inverter will jog within Acc/Dec time of jog operation, as shown in Fig.4-14.

Acc time of jog operation means the time accelerate from 0 Hz to max frequency, Dec time of jog operation means the time decelerate from max frequency to 0 Hz.

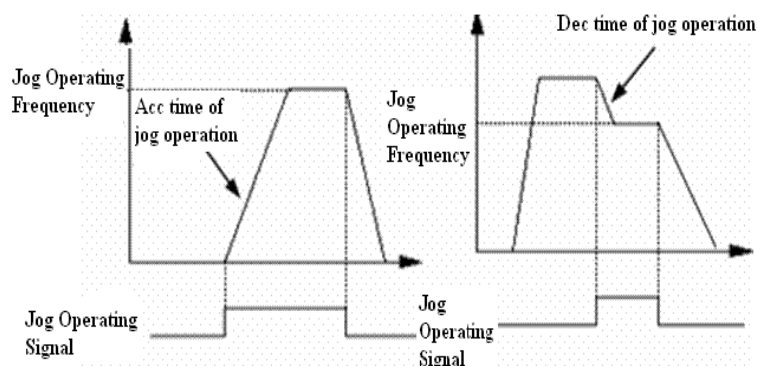

Fig 4-14 Jog operation

Note: (1) Jog operation can be controlled by panel, terminal and serial port.

(2) If jog operation command has been canceled, the inverter will decelerate and stop.

P3.09	Communication configuration	Range: 000~155	054
-------	-----------------------------	----------------	-----

You can change baud rate, digital format and communication mode by setting the lowest bit, ten bit, and hundred bit of

P3.09.

Lowest bit of LED: Set baud rate, the values are shown below:

- 0: 1200BPS
- 1: 2400BPS
- 2: 4800BPS
- 3: 9600BPS
- 4: 19200BPS
- 5: 38400BPS

Ten bit of LED: Set digital format, the values are show below:

- 0: 1-7-2 format, no parity check; 1 stop bit, 7 data bits, 2 stop bits, no parity.
- 1: 1-7-1 format, odd; 1 stop bit, 7 data bits, 1 stop bits, odd
- 2: 1-7-1 format, even; 1 stop bit, 7 data bits, 1 stop bit, even
- 3: 1-8-2 format, no parity check; 1 stop bit, 8 data bits, 2 stop bits, no parity.
- 4: 1-8-1 format, odd; 1 stop bit, 8 data bits, 1 stop bit, odd
- 5: 1-8-1 format, even; 1 stop bit, 8 data bits, 1 stop bit, even
- 6: 1-8-1 format, no parity check; 1 stop bit, 8 data bits, 1 stop bit, no parity.

Hundred bit of LED: undefined

Note: when choose Modbus-RTU communication mode, you should select digital format 3~6.

P3.10	Inverter address	Range: 0~248	1
-------	------------------	--------------	---

This parameter is used for identify the inverter's address in serial communication.

0 is the broadcast address. If inverter is a slave, it doesn't have to answer the 0 command.

248 is inverter host address. If set P3.10 to 248, it can send broadcast command to other inverters to realize multi-machine working.

P3.11	Communicate overtime checking time	Range: 0.0~1000.0s	0.0s
-------	------------------------------------	--------------------	------

When serial port communication failed and the lasting time is over this parameter, the inverter is considered as communication error.

When set the value to 0, the inverter will not detect the serial communication port and this function is disabled.

P3.12	Inverter response delay	Range: 0~1000ms	5ms
-------	-------------------------	-----------------	-----

It refers to time from inverter's serial port receiving and executing the command of host PC to returning response to it.

P3.13	Proportion of communication frequency	Range: 0.01~1.00	1.00
-------	---------------------------------------	------------------	------

The real running frequency= the proportion * frequency command receiving from RS485 port.

This parameter can also set running frequency proportion of several inverters in multimachine linkage mode.

P3.14	Accerlate time 2	Range: 0.1~6000.0	10.0
P3.15	Decelerate time 2	Range: 0.1~6000.0	10.0
P3.16	Accerlate time 3	Range: 0.1~6000.0	10.0
P3.17	Decelerate time 3	Range: 0.1~6000.0	10.0
P3.18	Accerlate time 4	Range: 0.1~6000.0	10.0
P3.19	Decelerate time 4	Range: 0.1~6000.0	10.0
P3.20	Accerlate time 5	Range: 0.1~6000.0	10.0
P3.21	Decelerate time 5	Range: 0.1~6000.0	10.0
P3.22	Accerlate time 6	Range: 0.1~6000.0	10.0
P3.23	Decelerate time 6	Range: 0.1~6000.0	10.0
P3.24	Accerlate time 7	Range: 0.1~6000.0	10.0
P3.25	Decelerate time 7	Range: 0.1~6000.0	10.0

Seven kinds of Acc/Dec time can be defined, and the inverter's Acc/Dec time 1~7 can be selected by different combination of control terminals. Please refer to the introductions of P4.00~P4.05 for the definitions of terminals used to select Acc/Dec time, also, you can refer to Acc/Dec time defined in P0.17 and P0.18.

P3.26	Multi-frequency 1	Range: lower limit of frequency~upper limit of frequency	5.00Hz
P3.27	Multi-frequency 2	Range: lower limit of frequency~upper limit of frequency	10.00Hz
P3.28	Multi-frequency 3	Range: lower limit of frequency~upper limit of frequency	20.00Hz
P3.29	Multi-frequency 4	Range: lower limit of frequency~upper limit of frequency	30.00Hz
P3.30	Multi-frequency 5	Range: lower limit of frequency~upper limit of frequency	40.00Hz
P3.31	Multi-frequency 6	Range: lower limit of frequency~upper limit of frequency	45.00Hz
P3.32	Multi-frequency 7	Range: lower limit of frequency~upper limit of frequency	50.00Hz

These frequencies will be used in multi-step speed operation and simple PLC operation, please refer to the introductions of P4.00~P4.05 and P8.

P3.33	Jump frequency 1	Range: 0.00—500.00Hz	0.00Hz
P3.34	Range of jump frequency 1	Range: 0.00—30.00Hz	0.00Hz
P3.35	Jump frequency 2	Range: 0.00—500.00Hz	0.00Hz
P3.36	Range of jump frequency 2	Range: 0.00—30.00Hz	0.00Hz
P3.37	Jump frequency 3	Range: 0.00—500.00Hz	0.00Hz
P3.38	Range of jump frequency 3	Range: 0.00—30.00Hz	0.00Hz

P3.33~P3.38 define the functions that will avoid resonant point of mechanical load. The frequency of the inverter can do jump operation near some jump frequency point, as shown in Fig. 6-15, you can define three ranges of jump frequency at most.

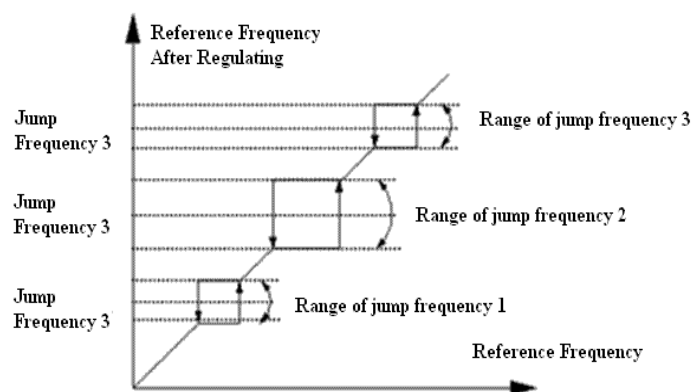

Fig.4-15 Jump frequency and range

P3.39	Set running time	Range: 0~65.535K hour	0.000K
P3.40	Accumulate running time	Range: 0~65.535K hour	*

If accumulated running time reach the setting time (P3.39), the inverter will output signal, refer to function P4.08~P4.09. P3.40 refers to the accumulating running time from out of factory till now.

P3.41	Display parameters selection 1	Range: 0000~FFFF	0000
-------	--------------------------------	------------------	------

P3.41 uses the 4 bits of this parameter (hex value) to control the displaying of b-09~b-24. Please transform the parameter to binary value when using. Each binary bit controls the displaying of one monitor parameter b. See Fig 4-16.

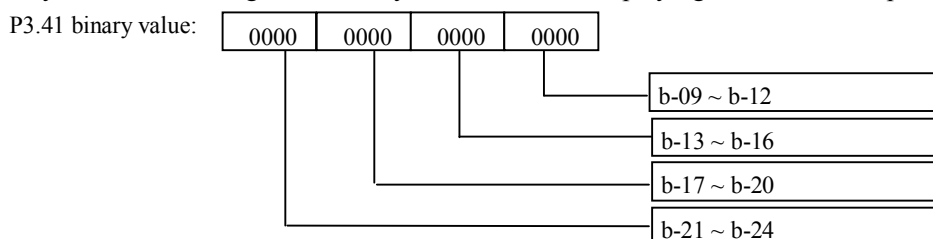

Fig.4—16 Display parameters selection 1

P3.42	Display parameters selection 2	Range: 0000~FFFF	0000
--------------	---------------------------------------	-------------------------	-------------

P3.42 uses the 4 bits of this parameter (hex value) to control the displaying of b-25~b-40. Please transform the parameter to binary value when using. Each binary bit controls the displaying of one monitor parameter b. See Fig4-17.

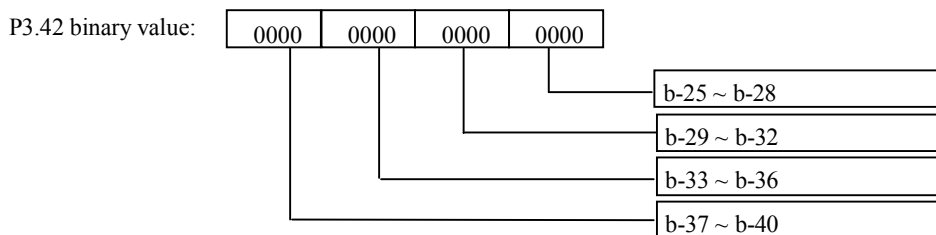

Fig.4—17 Display parameters selection 2

P3.43	Display parameters selection 3	Range: 0000~4040	0001
--------------	---------------------------------------	-------------------------	-------------

Ten bit, lowest bit: used to set stop status

Thousand bit, hundred bit: used to set running status

Example: display current value in running status and display DC bus voltage value in stop mode, please set P3.43=0304.

You can also press the key to view other monitor parameters.

P3.44	Display coefficient without unit	Range: 0.1~60.0	1.0
--------------	---	------------------------	------------

Display value of b-14 = Output frequency of inverter×P3.44 (proportion)

P3.45	JOG/REV switching	Range: 0, 1	0
--------------	--------------------------	--------------------	----------

P3.45 is used to select the working mode of JOG/REV key on the operate panel:

0: JOG

1: REV

4-2-5. Function parameters of terminal (Group P4)

P4.00	Function selection of input terminal X1	Range: 0~37	1
P4.01	Function selection of input terminal X2	Range: 0~37	2
P4.02	Function selection of input terminal X3	Range: 0~37	3
P4.03	Function selection of input terminal X4	Range: 0~37	10
P4.04	Function selection of input terminal X5	Range: 0~37	17
P4.05	Function selection of input terminal X6	Range: 0~37	18
P4.06	Function selection of input terminal X7	Range: 0~37	0
P4.07	Function selection of input terminal X8	Range: 0~37	0

Multi-function input terminals X1~X8 support various functions. You can define the function of X1~X8 by setting the value of P4.00~P4.07, refer to Table 4-1. Among these terminals, X7 corresponds to FWD and X8 corresponds to REV.

Table 4-1 Multi-function selection

Setting	Functions	Setting	Functions
0	Control terminals are idle	19	Frequency setting channel 1

1	Multi-speed choice terminal 1	20	Frequency setting channel 2
2	Multi-speed choice terminal 2	21	Frequency setting channel 3
3	Multi-speed choice terminal 3	22	Command switch to terminal
4	External forward jog input	23	Running command channel selection 1
5	External reverse jog input	24	Running command channel selection 2
6	Acc/Dec time terminal 1	25	Swing frequency input
7	Acc/Dec time terminal 2	26	Swing frequency reset
8	Acc/Dec time terminal 3	27	Close-loop is invalid
9	3-wire operation control	28	Pause the simple PLC operation command
10	Free stop input (FRS)	29	PLC is invalid
11	External stop command	30	Reset PLC stopping status
12	DC brake input command DB	31	Frequency switch to CI
13	Inverter running prohibition	32	Counter trigger signal input
14	Frequency increase (UP)	33	Counter reset signal input
15	Frequency decrease (DOWN)	34	External interrupt input
16	Acc/Dec prohibition	35	Pulse frequency input (only valid for X6)
17	External reset signal (clear the fault)	36	Actual length reset
18	External fault input (normal open)	37	

Introductions of the functions shown in Table4-1:

1~3: Multi-speed control terminals. Up to 7 kinds of speed can be set by different ON/OFF (open/close) combination of the function terminals, at the same time, you can select corresponding Acc/Dec time.

Table 4-2 On/Off combination of function terminals

K ₃	K ₂	K ₁	Frequency setting	Acc/Dec time
OFF	OFF	OFF	Common running frequency	Acc/Dec time 1
OFF	OFF	ON	frequency 1	Acc/Dec time 1
OFF	ON	OFF	frequency 2	Acc/Dec time 2
OFF	ON	ON	frequency 3	Acc/Dec time 3
ON	OFF	OFF	frequency 4	Acc/Dec time 4
ON	OFF	ON	frequency 5	Acc/Dec time 5
ON	ON	OFF	frequency 6	Acc/Dec time 6
ON	ON	ON	frequency 7	Acc/Dec time 7

The above frequencies can be used in multi-speed running and simple PLC running, please see below example:

The definition of X1, X2 and X3 are shown below:

P4.00=1, P4.01=2, P4.03=3, X1, X2 and X3 are used to achieve multi-speed operation, as shown in Fig.4-18.

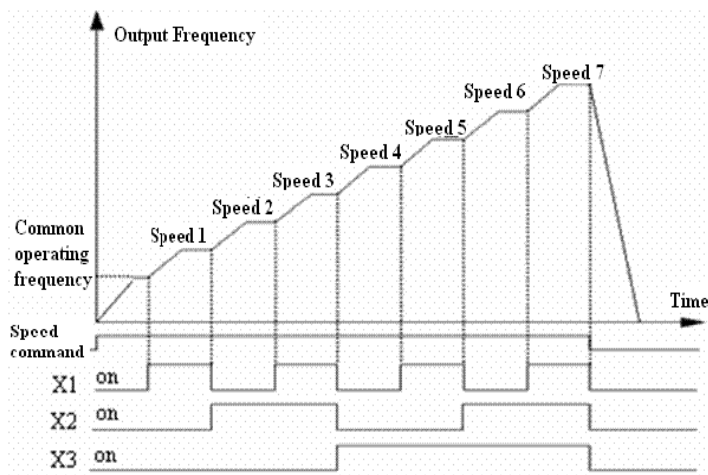

Fig.4-18 Multi-speed operation

In Fig.4-19 terminal control is selected, the running direction is controlled by K₇, K₈. In Fig.4-18, inverter can run at multi-speed 1~7 or normal speed by controlling the ON/OFF of K₁, K₂, K₃.

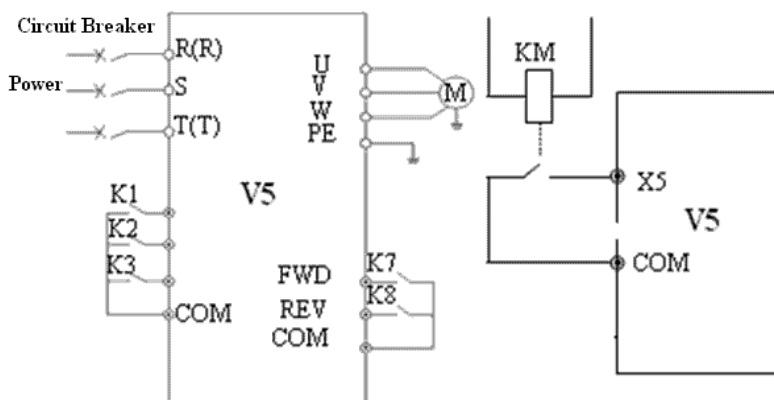

Fig.4-19 Wire of multi-speed

Fig.4-20 External device fault input

4~5: External jog input JOGP/JOGR. When choose terminal control (P0.03=1), JOGP is forward jog operation, JOGR is reverse jog operation. Jog operating frequency and jog Acc/Dec time are defined in P3.06~P3.08.

6~8: Acc/Dec time selection

Table 4-3 Acc/Dec time selection

Terminal 3	Terminal 2	Terminal1	Acc/Dec time selection
OFF	OFF	OFF	Acc time 1/Dec time 1
OFF	OFF	ON	Acc time 2/ Dec time 2
OFF	ON	OFF	Acc time 3/ Dec time 3
OFF	ON	ON	Acc time 4/ Dec time 4
ON	OFF	OFF	Acc time 5/ Dec time 5
ON	OFF	ON	Acc time 6/ Dec time 6
ON	ON	OFF	Acc time 7/ Dec time 7

Through the ON/OFF combination of the terminal, you can select acc/dec time 1~7.

9: 3-wire operation control. Refer to the introduction of P4.08.

10: Free stop (FRS) . This function has the same meaning as the description in P2.05, while here it is controlled by terminal controlling for remote application.

11: External stop command. This command is valid for all the running command channels and it can stop the inverter according to the setting mode in P2.05.

12: DC braking command DB. DC brake the motor through the terminal in stop mode, to realize urgent stop or precision positioning. Brake starting frequency, brake current and time are defined in P2.06~P2.08. Brake time is the bigger one between P2.07 and terminal lasting time.

13: Inverter running prohibition. When the terminal is enabled, the inverter in running mode will free stop and prohibit to restart in standby mode. This function is suitable for safe linkage.

14~15: Frequency up (UP)/Frequency down (DOWN). The terminal can be used to increase or decrease the frequency. Its function is the same with operating keys on the panel, which enables remote control. This terminal is enabled when P0.01=3. Increase or decrease rate is determined by P4.09.

16: Acc/Dec prohibition. The terminal can make the motor keep current speed without being influenced by external signal. It is invalid when normal decelerate stop.

17: External reset signal. The inverter can be reset via this terminal when the inverter has a fault. The function of this terminal is the same to  on the panel.

18: External fault signal input. The fault signal of external equipment can be input via the terminal, which is convenient for the inverter to monitor the external equipment. Once the inverter receives the fault signal, it will display “E-13”. Refer to Fig.4-20.

19~21: Frequency setting channel 1. Different ON/OFF combination of terminals 19, 20 and 21 can select frequency as shown in Table 4-4. The priority of terminal setting and function code P0.01 setting: the final setting is valid.

Table 4-4 Frequency selection

Frequency setting terminal 3	Frequency setting terminal 2	Frequency setting terminal 1	Frequency setting channel
OFF	OFF	OFF	Keep the frequency setting
OFF	OFF	ON	Function code setting
OFF	ON	OFF	Terminal UP/DOWN setting
OFF	ON	ON	Serial port setting
ON	OFF	OFF	VI
ON	OFF	ON	CI
ON	ON	OFF	PULSE
ON	ON	ON	Combination setting (refer to P3.01)

22: Command switch to the terminal. When this terminal is enabled, the running command channel will switch to terminal command channel.

23~24: Select the command channel by terminal. Select the command channel by terminal ON/OFF combination. Please see table 4-5. The priority of terminal and P0.03: the final setting is valid.

Table 4-5 running command channel

Terminal 2	Terminal 1	Control mode
OFF	OFF	Keep running command channel
OFF	ON	Panel command channel
ON	OFF	Terminal command channel
ON	ON	Serial port command channel

25: Swing frequency input. When the swing frequency mode is manual input, the swing frequency function is valid when this terminal is valid, refer to the introductions of P9.

26: Reset swing frequency. No matter the swing frequency mode is “Manual” or “Auto”, when this terminal is ON, the status of swing frequency in the inverter will be cleared. Disconnect this terminal can restart the swing frequency. Refer to P9.

27: Close-loop disabled. Switch between the close-loop operation and low level operation. When switching to low level operation mode, start/stop, direction and acc/dec time are accord to the setting of related running mode.

Note: Switching between close-loop operation and low level operation can be realized only when close-loop is enabled (P7.00 =1).

28: Pause the PLC operation. Pause the running PLC. Inverter run at 0 frequency when this terminal is valid, PLC running time is not counted. When the terminal is invalid, PLC will auto-track the speed and continue to run. Please refer to P8.

29: PLC disabled. This terminal can be used to flexible switch the PLC operation and low level operation.

Note: The switching between PLC operation and low level operation are valid only when PLC is running (the lowest bit of P8.00 is not 0)

30: Reset PLC stopping status. When PLC is in stopping status, the enabled terminal can clear PLC running stage, running time, running frequency and other informations of PLC stopping memory. Refer to P8 for instructions.

31: Frequency switches to CI. The frequency setting channel switches to CI when this terminal is valid. If it is invalid, the frequency setting channel will restore.

32: Counter trigger signal input. Counter pulse input of internal counter, the max frequency is 200Hz. The count value is latched. Refer to P4.21, P4.22.

33: Counter reset input. Reset the internal counter of inverter. Use with function No.32 (counter trigger signal input).

34: External interrupt input. After receiving external interrupt input signal, inverter will lock output and run at 0 Hz, once the interrupt input signal release, the inverter will auto-track speed and continue to run.

35: Pulse frequency input (only valid for X6). Set frequency via this terminal. The relationship between input pulse and setting frequency please refer to P1.11~P1.15.

36: Actual length reset input. If this terminal is enabled, the actual length parameter P9.09 will be set to 0.

P4.08	FWD/REV operation mode selection	Range: 0~3	0
-------	----------------------------------	------------	---

This parameter defines four operation modes controlled by external terminal.

0: 2-wire control mode 1

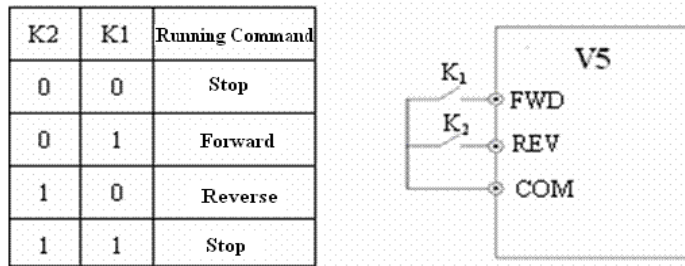

Fig.4-21 2-wire operation mode 1

1: 2-wire control mode 2

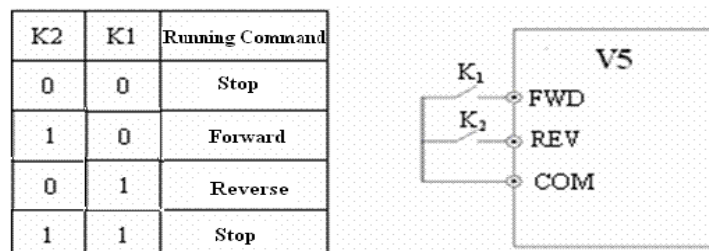

Fig.4-22 2-wire operation mode 2

2: 3-wire control mode 1

- SB1: Stop button
- SB2: Forward button
- SB3: Reverse button

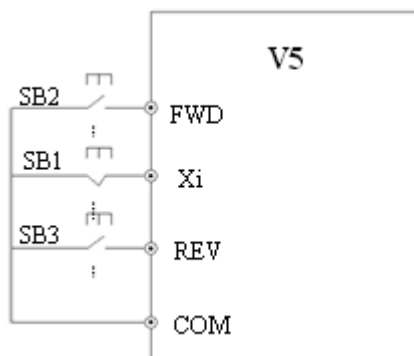

Fig. 4-23 3-wire operation mode 1

Xi is the multi-function input terminal of X1~X6; here you should define its function to No.9 “3-wire control mode”.

3: 3-wire control mode 2

SB1: Stop button

SB2: Running button

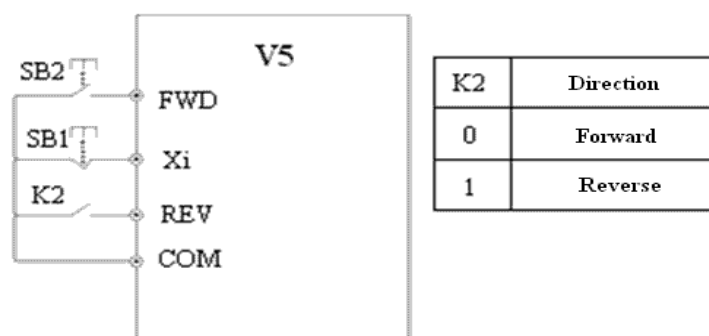

Fig.4-24 3-wire control mode 2

Xi is the multi-function input terminal of X1~X6, here you should define its function to No.9 “3-wire control mode”.

Note: When the inverter alarming stop, if the running command channel is terminal and terminal FWD/REV is valid, inverter will reset the error and restart immediately.

P4.09	UP/DOWN speed rate	Range: 0.01~99.99Hz/s	1.00 Hz/s
-------	--------------------	-----------------------	-----------

This parameter defines the changing rate of setting frequency changed by UP/DOWN terminal.

P4.10	Bi-direction open-collector output terminal OC	Range: 0~20	0
P4.11	Relay output function selection	Range: 0~20	15

Bi-direction open-collector output terminal OC, the options of this parameter are shown in Table 4-6.

Table 4-6 Functions of output terminals

Setting	Functions	Setting	Functions
0	Inverter is running (RUN)	11	PLC one period running is completed
1	Frequency arriving signal (FAR)	12	Reach the setting counter value
2	Frequency level detection signal (FDT1)	13	Reach the middle counter value
3	Frequency level detection signal (FDT2)	14	Inverter running preparation finished (RDY)
4	Overload pre-alarm (OL)	15	Inverter fault
5	Inverter under voltage locking (LU)	16	Running at start frequency
6	External fault stop (EXT)	17	DC braking when startup

7	Upper limit of output frequency (FH)	18	DC brake when stop
8	Lower limit of output frequency (FL)	19	High and lower limit of swing frequency
9	Inverter zero speed running	20	Reach the preset running time
10	Simple PLC running completed	21	

Instructions of the functions shown in Tabel 4-6:

0: Inverter is running (RUN) . Inverter is running and the terminal outputs indication signal.

1: Frequency arriving signal (FAR) . Refer to P4.12.

2: Frequency level detection (FDT1) . Refer to P4.11~ P4.12.

3: Frequency level detection (FDT2) . Refer to P4.13~P4.14.

4: Overload pre-alarm (OL) . If the output current is higher than the value in P4.24 and the time is longer than the value in P4.25, the inverter will output indicate signals. This function is mainly used in pre-alarm.

5: Inverter under voltage lock and stop (LU) . While inverter is running, if the bus voltage is lower than setting level, LED will show E-11.

6: External fault stop (EXT) . Inverter outputs indication signal when it show E-13 alarm (error trip).

7: Output frequency arrive upper limit (FH) . An indicate signal will be output if setting frequency \geq upper limit of frequency and the running frequency arrives the upper limit of frequency.

8: Output frequency arrive lower limit (FL) . An indicate signal will be output if setting frequency \leq lower limit of frequency and the running frequency is lower than low limit of frequency.

9: Inverter zero speed running. An indicate signal will be output when inverter output frequency is 0 and is still in running status.

10: Simple PLC running completed. An indicate signal (single pulse signal, 500ms width) will be output if the simple PLC running is completed.

11: PLC one period running is completed. An indicate signal (single pulse signal, 500ms width) will be output if one cycle running of simple PLC is finished.

12: Reach the setting counter value

13: Reach the setting middle counter value

12, 13 refer to P4.22~P4.23 for details.

14: Inverter running preparation is completed (RDY) . This signal outputting means inverter bus voltage is normal, running prohibition terminal is invalid, enable to accept startup command.

15: Inverter fault. If there is fault when inverter is running, indicate signal will be output.

16: Running at start frequency

17: DC brake when startup

18: DC brake when stop

19: Upper and lower limit of swing frequency. An indicate signal will be output if the swing frequency range calculated by center frequency exceeds the upper/lower limit frequency. See Fig 4-25.

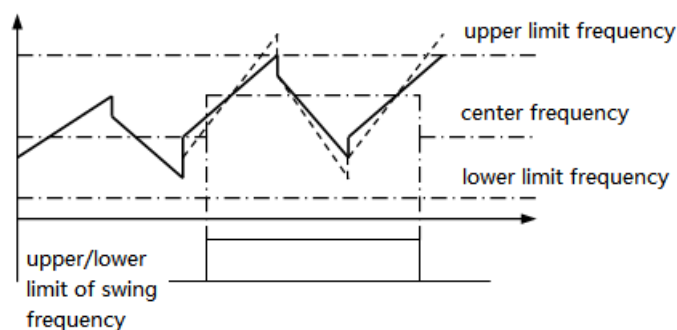

Fig.4-25 Upper and lower limit of swing frequency

20: Reach the setting running time. When the accumulating running time (P3.40) arrive the setting time (P3.39), an indication signal will be output.

P4.12	Detecting range of frequency arrive (FAR)	Range: 0.00~50.00Hz	5.00Hz
-------	---	---------------------	--------

This parameter is the additional definition of No. 1 function in Table 4-6. As shown in Fig.4-26, when the output frequency of inverter is in the detecting range of setting frequency, pulse signal will be output.

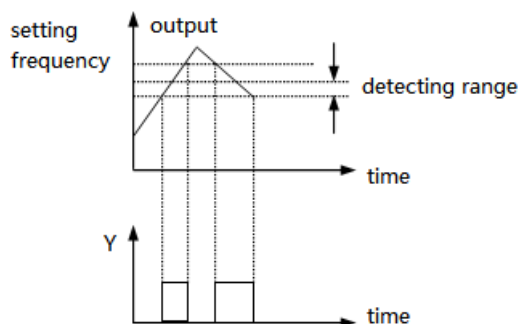

Fig 4-26 Frequency arriving signal

P4.13	FDT1 (frequency level) voltage	Range: 0.00~upper limit of frequency	10.00Hz
P4.14	FDT1 lag	Range: 0.00~50.00Hz	1.00Hz
P4.15	FDT2 (frequency level) voltage	Range: 0.00~upper limit of frequency	10.00Hz
P4.16	FDT2 lag	Range: 0.00~50.00Hz	1.00Hz

P4.13~P4.14 is the additional definition of No.2 function in Table.4-6, P4.15~P4.16 is the additional definition of No.3 function in Table.4-6, their using method are the same. The following takes P4.13~P4.14 as an example to introduce. When the output frequency is over one frequency(FDT1 voltage), indication signal will be output until the output frequency decreasing below one frequency of FDT1(FDT1 voltage—FDT1 lag), as shown in Fig. 4-27.

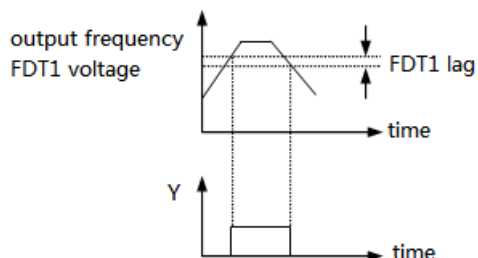

Fig.4-27 FDT level

P4.17	Analog output selection (AO)	Range: 0~7	0
P4.18	Analog output gain (AO)	Range: 0.50~2.00	1.00

Table 4-7 Output terminals

No.	Function	Range
0	Output frequency	0~upper limit frequency
1	Output current	0~2 × rated current
2	Output voltage	0~1.2 × rated voltage of load motor
3	Bus voltage	0~800V
4	PID setting	0~10V
5	PID feedback	0~10V
6	VI	0~10V
7	CI	0~10V/4~20mA

For analog output AO, you can adjust the output gain to change the measuring range or calibrate the meter.

P4.19	AO output mode	Range: 0, 1	1
	0: 4 ~20mA		
	1: 0 ~10V		

P4.20	DO output terminal	Range: 0~120	0
--------------	---------------------------	---------------------	----------

Refer to Table 4-7 and 4-6 for function selection of DO output terminal.

P4.21	DO max pulse output frequency	Range: 0.1~20.0 (max 20K)	10.0K
--------------	--------------------------------------	----------------------------------	--------------

This parameter defines the max output frequency of DO terminal.

P4.22	Counter value setting	Range: P4.23~9999	0
P4.23	Middle counter value setting	Range: 0~P4.22	0

P4.22, P4.23 is the additional definition of No.12, 13 functions in table 4-6.

Counter value setting: when Xi receives certain quantity pulses, OC or relay will output a indicator signal.

For example: as shown in Fig. 4-28, when the eighth pulse is received by terminal Xi, OC outputs an indicating signal and P4.22=8.

Middle counter value setting: When Xi receives certain quantity pulses, OC or relay will keep output a signal until the counter value arrives.

As shown in Fig. 4-28, when Xi receives the 5th pulse, the realy outputs indication signal. It keeps outputting until counter value 8 arrived. At this time, P4.23=5. The middle counting value will be disabled if it is bigger than preset counting value.

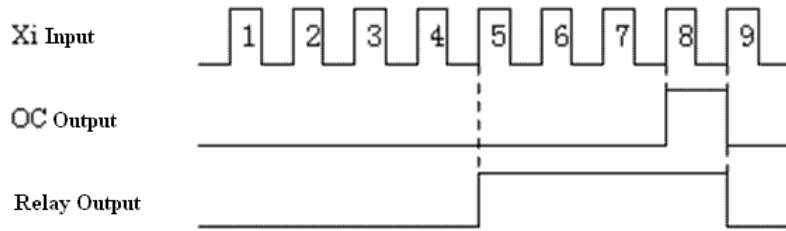

Fig.4—28 Preset counting values arrived and Middle counting value arrived

P4.24	Overload pre-alarm detection level	Range: 20~200 (%)	130(%)
P4.25	Overload pre-alarm delay time	Range: 0.0~20.0s	5.0s

If output current is over the current detecting level P4.24 continuously (Actual detecting current level= $P4.24 \times$ inverter's rated current), Bi-direction open-collector will output valid signal (refer to Fig.4-29 and P4.11 for details).

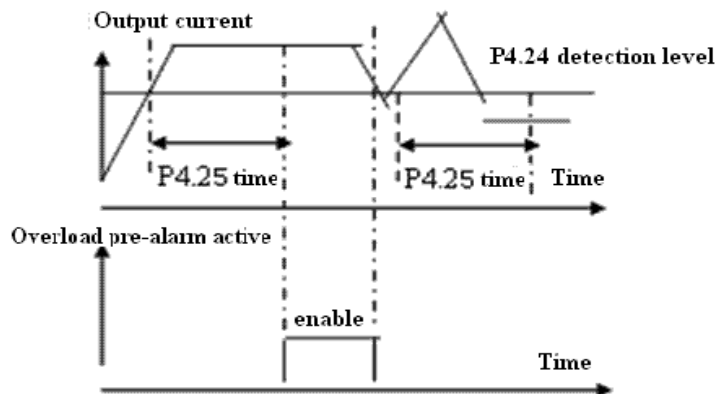

Fig.4-29 Overload pre-alarm

4-2-6. Protection function parameters (Group P5)

P5.00	Motor overload protection mode selection	Range: 0,1	0
-------	--	------------	---

This parameter defines the protection mode when overload or overheat occurs.

0: Inverter locks the output. When overload or overheat occurs, inverter will lock output and the motor will free stop.

1: Disabled. Motor has no overload protection. (Be careful to use)

P5.01	Motor overload protection coefficient	Range: 20(%) ~120(%)	100(%)
-------	---------------------------------------	----------------------	--------

This parameter is used to set sensitivity of thermal relay protection for inverter load motor. When the output current value of load motor can not match the rated current of the inverter, the motor can be thermal protected, as shown in Fig.4-30.

Use the following coefficient to calculate.

$$[P5.01] = \frac{\text{Motor rated current}}{\text{Inverter rated output current}} \times 100$$

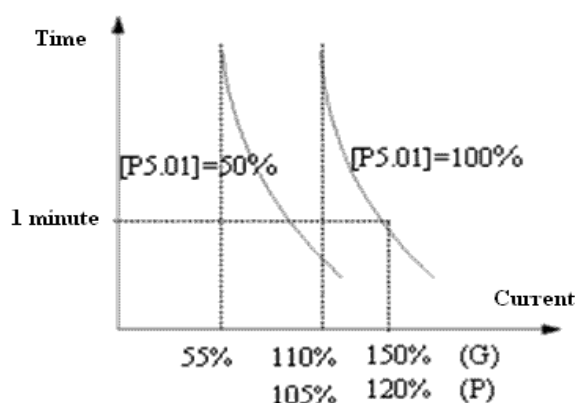

Fig.4-30 Thermal relay protection

Note: When one inverter run with multi-motors, inverter's thermal relay protection will be disabled. Therefore, please install thermal relay in the input wire of each motor to protect motor more efficiently.

P5.02	Over-voltage speed loss selection	Range: 0, 1	1
P5.03	Speed loss overvoltage point	Range: 380V: 120~150 (%) 220V: 110~130 (%)	140(%) 120(%)

0: disable

1: enable

During deceleration, the motor's decelerate rate may be lower than that of inverter's output frequency due to the load inertia. At this time, the motor will feedback the energy to the inverter, it will cause the inverter DC bus voltage too high. If no measures are taken, the inverter will be overvoltage protected.

During the deceleration, the inverter detects the bus voltage and compares it with the speed loss over voltage point defined by P5.03. If the bus voltage exceeds the speed loss overvoltage point, the inverter output frequency will not decrease. When the bus voltage is lower than the point again, it continues to decelerate run, as shown in Fig.4-31.

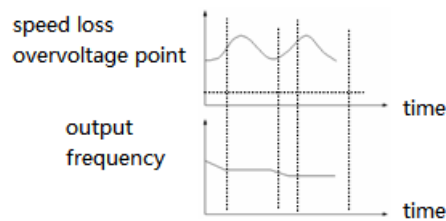

Fig. 4-31 Overvoltage speed loss function

P5.04	Auto current limiting level	Range: 110~200(%)	150(%)
P5.05	Frequency decrease rate when current limiting	Range: 0.00~99.99Hz/s	10.00Hz/s
P5.06	Auto current limiting selection	Range: 0, 1	1

Auto current limiting function is used to limit the load current smaller than the value defined in P0.54. Therefore the inverter will not trip due to surge over-current. This function is especially useful for the applications with big load inertia or big change of load.

Auto current limiting level (P5.04) defines the threshold of auto current limiting. The range of it is the percentage of the inverter rated current.

Frequency decrease rate when current limiting (P5.05) defines the rate of output frequency when the inverter is in auto current limiting status.

If the decrease rate is too small, auto current limiting status may not change and overload fault may occur. If it is set too big, the frequency will change too sharply and thus the inverter may be in generating status for long time, which may result in overvoltage protection.

Auto current limiting function is always enabled in accelerate or decelerate process. P5.06 (auto current limiting) will decide if the auto current limiting function is enabled when constant speed running.

P5.06=0, Auto current limiting function is disabled in constant speed operating process;

P5.06=1, Auto current limiting function is enabled in constant speed operating process;

In auto current limiting process, the inverter output frequency may change; therefore, when the inverter output frequency is required to be stable, this function is not recommended.

P5.07	restart after power off	Range: 0,1	0
P5.08	waiting time of restart after power off	Range: 0.0~10.0s	0.5s

P5.07 = 0, Restart after instantaneous power off is disabled.

P5.07 = 1, Restart after instantaneous power off is enabled.

If instantaneous power off (LED shows E-11) occurs when inverter is in running status, after repowering, it will detect speed automatically and then restart after the waiting time (P5.08). During the waiting time, the inverter will not start even you input running command. If input stop command, the inverter will release the speed checking and restart status.

P5.09	Auto reset fault times	Range: 0~10	0
P5.10	Interval of auto reset fault	Range: 0.5~20.0s	5.0s

When the inverter is in running process, it may have a fault and stop output by accident for overload fluctuating. To avoid the pause of the device, you can use auto fault reset function. In the resetting process, inverter will restart after auto-checking the speed. If the inverter can not reset successfully in auto reset fault times, fault protection will be enabled and output will be stop. This function will be OFF when auto reset times is 0.

Note: (1) When use this function, make sure inverter has no substantiality fault.

(2) This function is invalid for the fault caused by overload and overheats.

4-2-7. Fault recording parameters (Group P6)

P6.00	last fault record	Range: 0~23	0
P6.07	Last 2 fault record	Range: 0~23	0
P6.08	Last 3 fault record	Range: 0~23	0
P6.09	Last 4 fault record	Range: 0~23	0
P6.10	Last 5 fault record	Range: 0~23	0
P6.11	Last 6 fault record	Range: 0~23	0

0: no fault

1~17: E-01~E-17 fault, refer to chapter 5.

P6.01	Output frequency of last fault	Range: 0~upper limit of frequency	0
P6.02	Setting frequency of last fault	Range: 0~upper limit of frequency	0
P6.03	Output current of last fault	Range: 0~999.9A	0
P6.04	Output voltage of last fault	Range: 0~999V	0
P6.05	DC bus voltage of last fault	Range: 0~800V	0
P6.06	Module temperature of last fault	Range: 0~100	0

4-2-8. Close-loop control parameters (Group P7)

Analog feedback control system:

Pressure value is input in VI, and feedback value (4~20mA) of pressure sensor is input to inverter CI then pass through the internal PI adjustor to form analog close-loop control system, as shown in Fig4-32.

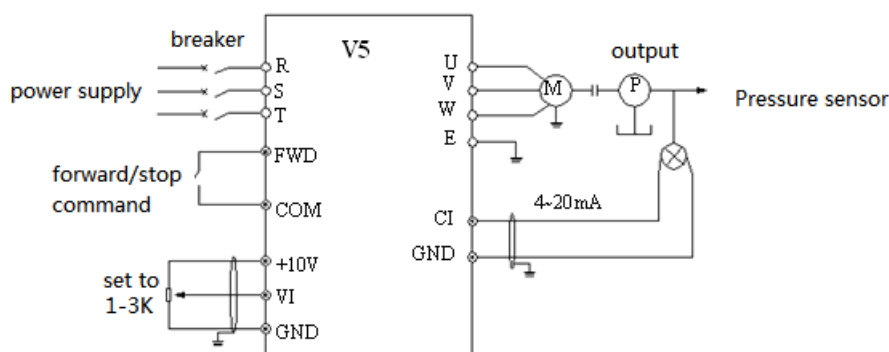

Fig.4-32 Analog feedback control system with internal PI

Principle diagram of inverter's internal PI adjustor is shown below:

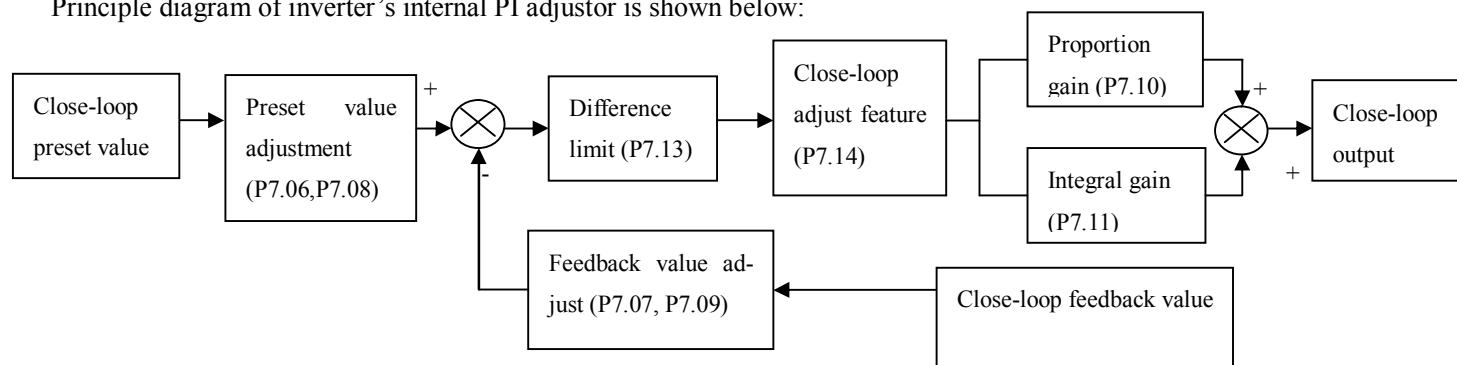

Fig. 4-33 PI control principle diagram

The definition of close-loop value, feedback value, difference limit and proportion/integral parameter in Fig 4-33 are the same to normal PI definition. Please refer to P7.01~P7.11. The relationship between preset value and expect feedback value is shown in Fig 4-34. The preset value is based on 10V; the feedback value is based on 20mA.

The aim of preset value adjustment and feedback value adjustment is to confirm the their relationship and size, as shown in

Fig.4-33.

In actual applications, if the motor speed increases with the preset value increasing, it is positive feature; if the motor speed decreases with the preset value increasing, it is negative features.

The two close-loop features can be set via P7.14, as shown in Fig4-35.

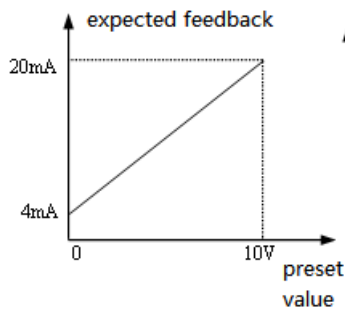

Fig.4-34 Preset and expected feedback

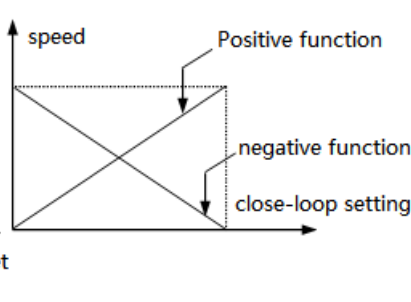

Fig.4-35 Close-loop adjustment feature diagram

After confirming the system, the procedure of setting close-loop parameters is shown below:

- (1) Confirm the close-loop setting and feedback channel (P7.01, P7.02).
- (2) The relationship between close-loop setting and feedback value (P7.06~P7.09).
- (3) Confirm the close-loop adjustment features (P7.14=1 negative function; 0 is positive function), as shown in Fig4-35.
- (4) Set the close-loop preset frequency (P7.16~ P7.17).
- (5) Set close-loop filter time, sampling cycle, difference limit and gain coefficient (P7.03, P7.04, P7.12, P7.13).

P7.00	Close-loop function selection	Range: 0, 1	0
-------	-------------------------------	-------------	---

0: Close-loop control is disabled

1: PI close-loop control is enabled

P7.01	Close-loop setting channel	Range: 0, 1, 2	1
-------	----------------------------	----------------	---

0: Digital setting

1: VI (0~10V) voltage setting

2: CI analog setting. 0~10V voltage or 4~20mA current are available. For speed close-loop, 10V corresponds to the synchronized speed of the motor's max output frequency.

P7.02	Feedback channel selection	Range: 0~6	1
-------	----------------------------	------------	---

0: VI (0~10V) voltage input

1: CI analog input

2: VI +CI

3: VI - CI

4: Min {VI, CI}

5: Max {VI, CI}

P7.03	Setting channel filter	Range: 0.01~50.00s	0.50s
P7.04	Feedback channel filter	Range: 0.01~50.00s	0.50s

External setting channel and feedback channel have noise. To filter the channel by setting the filter time P7.03 and P7.04. the longer the time, the stronger the noise immunity ability. But the reponse will be slow.

P7.05	Digital setting	Range: 0.00~10.00V	0.00V
-------	-----------------	--------------------	-------

If P7.01=0, the value of P7.05 will be considered as the setting value of close-loop control system. Therefore, modify the value of P7.05 to change the system setting value when controlling the close-loop system by operate panel or serial port.

P7.06	Min setting value	Range: 0.0~Max setting value	0.0%
P7.07	Feedback value corresponding to min setting	Range: 0.0~100.0 (%)	0.0%
P7.08	Max setting value	Range: min reference~100.0 (%)	100.0%
P7.09	Feedback value corresponding to max setting	Range: 0.0%~100.0 (%)	100.0%

P7.06~P7.09 defines the relationship curve of analog close-loop setting value and expected feedback. See Fig4-36.

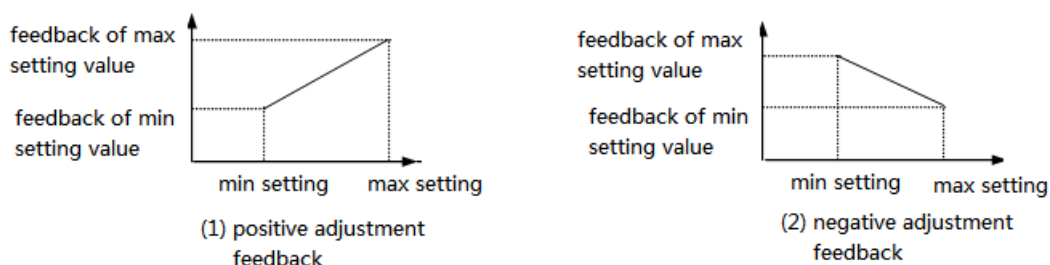

Fig. 4-36 setting and feedback curve

P7.10	Proportional gain KP	Range: 0.000~9.999	0.050
P7.11	Integral gain KI	Range: 0.000~9.999	0.050
P7.12	Sampling cycle T	Range: 0.01~10.00s	1.00s

The bigger the proportion gain KP, the quicker the response, but too big may lead to surge easily.

Only adjust with proportion gain KP, deviation can not be eliminated, integral gain KI can be used to form PI control to eliminate the deviation. The bigger the Ki, the quicker the response of changing deviation, but too big of the Ki may lead to surge easily.

Sampling cycle T is the sampling cycle of feedback value. PI regulator calculates once in every sampling cycle, the longer the cycle, the slower the response.

P7.13	Limit of deviation	Range: 0.0~20.0(%)	2.0(%)
-------	--------------------	--------------------	--------

The max deviation value of close-loop setting is shown in Fig4-37, if the feedback value is in this range, PI regulator will stop adjusting. This function is useful to improve accuracy and stability of the system.

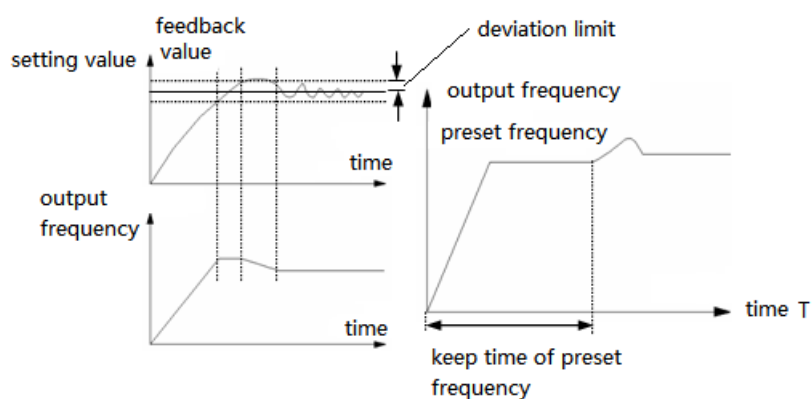

Fig.4-37 Limit of deviation

Fig.4-38 close-loop preset frequency running

P7.14	Close loop adjustment characteristic	Range: 0, 1	0
-------	--------------------------------------	-------------	---

0: Positive. The motor speed increases with the increasing of setting value.

1: Negative. The motor speed decreases with the increasing of setting value.

Note: Define the relationship between setting value and speed.

P7.15	Integral adjustment selection	Range: 0, 1	0
-------	-------------------------------	-------------	---

0: Stop integral adjustment when the frequency reaches upper limit or lower limit.

1: Continue the integral adjustment when the frequency reaches upper limit or lower limit.

For the system need quick response, it is better to cancel the continue integral adjustment.

P7.16	Close-loop preset frequency	Range: 0~upper limit of frequency	0.00Hz
P7.17	Holding time of close-loop preset frequency	Range: 0.0~250.0s	0.1s

This function can make the close-loop adjustment enter stable status.

When inverter is in close-loop running mode, it accelerates to close-loop preset frequency P7.16 in acc time, and is running for a while (P7.17), then runs according to close-loop features. Refer to Fig 4-38.

Note: If no need the function of close-loop preset frequency, please set the preset frequency and holding time to 0.

P7.18	Threshold of PI zero frequency wakeup	Range: 0.00~500.0Hz	0.01Hz
P7.19	Backlash of PI zero frequency wakeup	Range: 0.00~500.0Hz	0.01Hz

The two function parameters are used to set PI threshold and backlash of zero-frequency wakeup.

If you set the frequency to 0 Hz, PI threshold of zero-frequency wakeup will be disabled.

For example: Fig 4-39:

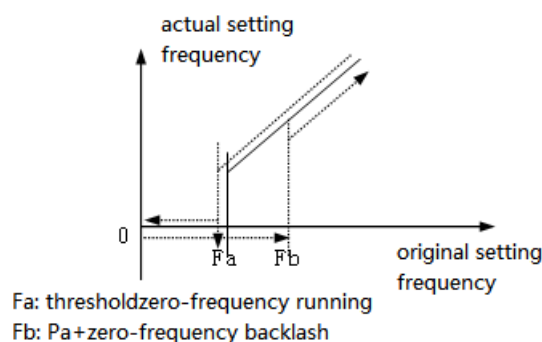

Fig.4-39 zero-frequency backlash

Start process:

After start command is sent, the motor will start and accelerate to the preset frequency in the Acc time when the setting frequency reaches or exceeds Fb.

Stop process:

The inverter will not stop immediately if the setting frequency is lower than Fb, only when the setting frequency reaches Fa, the inverter will stop output.

Fa points to zero-frequency wakeup threshold (P7.18), Fb-Fa points to zero-frequency wakeup backlash (P7.19).

This function can realize dormant function and save the energy, besides, the inverter will not frequent start at threshold frequency by defining the backlash width.

4-2-9. Simple PLC operation parameters (Group P8)

Simple PLC function is a multi-speed generator, inverter can auto-change frequency and direction according to the running time to satisfy the technical requirements. See Fig4-40.

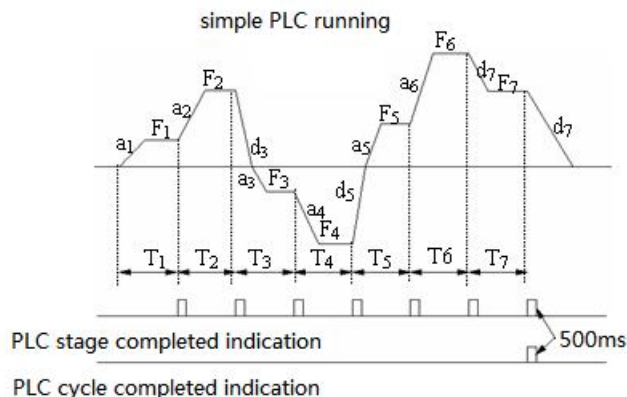

Fig.4-40 Simple PLC running

In Fig 4-40, $a_1\sim a_7$, $d_1\sim d_7$ are the Acc/Dec time of each stage and they are set by Acc/Dec time parameters P0.17, P0.18 and P3.14~P3.2. $F_1\sim F_7$, $T_1\sim T_7$ are the running frequency and running time and they are set by P8.01~P8.14.

P8.00	Simple PLC running	Range: LED lowest bit: 0~3; ten bit: 0, 1; hundred bit: 0, 1; Thousand bit: 0, 1.	0000
-------	--------------------	---	------

Lowest bit of LED: PLC running mode selection

0: Disabled. PLC running mode is invalid.

1: Stop after one cycle. As shown in Fig.4-41. If inverter stops after single cycle operation, running command should be input once again to start the inverter.

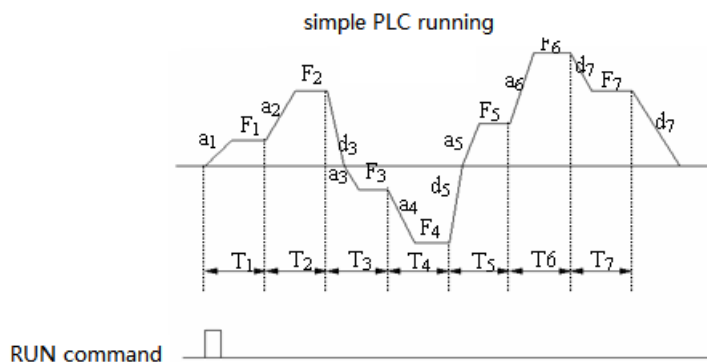

Fig. 4-41 PLC stop mode after single cycle

2: Keep the final value after single cycle. As shown in Fig.4-42, Inverter will keep the running frequency, direction of the last stage after single cycle is completed, then it will stop in dec time if stop command is input.

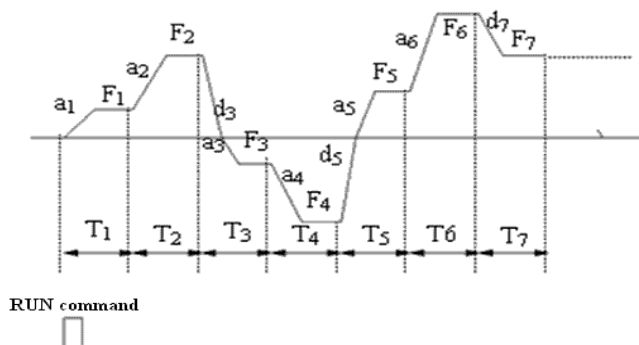

Fig. 4-42 PLC holding mode after single cycle

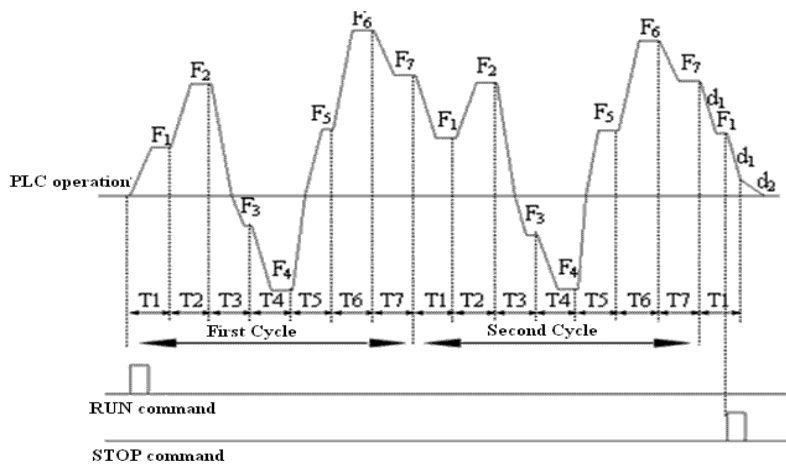

Fig. 4-43 PLC continuous running mode

3: Continuous cycle. See Fig.4-43, inverter start next cycle after one cycle finished, it will stop when stop command is input.

LED Ten bit: restart after pause

0: restart from stage 1. Stop caused by stop command, fault or power-off, restart from the first stage.

1: Continue to run from the frequency of stopping stage. Stop caused by stop command or fault, inverter auto-records current stage running time. It will enter this stage after restarting and continue running, see Fig 4-44.

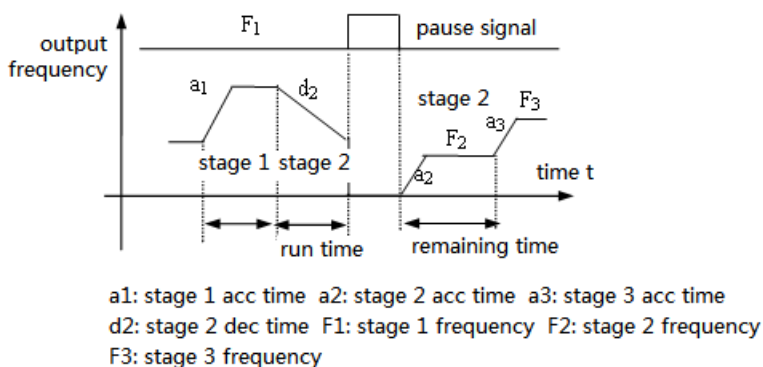

Fig.4-44 PLC start mode 1

Hundred bit: PLC status parameter storage selection when power-off

0: Not save. The inverter doesn't save the PLC status. It restarts from stage 1 when power on.

1: Save. The inverter saves the PLC status including stage frequency and running time when power-off. It restart according to the running mode defined by LED ten bit(restart after pause).

Thousand bit: the unit of PLC running time

0: second

1: minute

This unit is only valid for the definition of PLC running time. The unit of Acc/Dec time during PLC is running is set by P0.16.

Note: (1) This stage is invalid when the PLC running time is set to 0.

(2) You can control pause, invalid, run and others of the PLC process via terminals, refer to P4 for details.

P8.01	Stage 1 setup	Range: 000~621	000
P8.02	Running time of stage 1	Range: 0.1~6000.0	10.0
P8.03	Stage 2 setup	Range: 000~621	000
P8.04	Running time of stage 2	Range: 0.1~6000.0	10.0
P8.05	Stage 3 setup	Range: 000~621	000
P8.06	Running time of stage 3	Range: 0.1~6000.0	10.0

P8.07	Stage 4 setup	Range: 000~621	000
P8.08	Running time of stage 4	Range: 0.1~6000.0	10.0
P8.09	Stage 5 setup	Range: 000~621	000
P8.10	Running time of stage 5	Range: 0.1~6000.0	10.0
P8.11	Stage 6 setup	Range: 000~621	000
P8.12	Running time of stage 6	Range: 0.1~6000.0	10.0
P8.13	Stage 7 setup	Range: 000~621	000
P8.14	Running time of stage 7	Range: 0.1~6000.0	10.0

P8.01~P8.14 use the lowest bit, ten bit and hundred bit of LED to define the PLC running frequency, direction and acc/dec time.

Lowest bit of LED: frequency setting

0: Multi-frequency i , $i=1\sim7$, defined by P3.26~P3.32.

1: Frequency is set by P0.01

Ten bit of LED: Operating direction selection

0: Run forward

1: Run reverse

2: Decided by operating instructions

Hundred bit of LED: Acc/Dec time selection

0: Acc/Dec time 1

1: Acc/Dec time 2

2: Acc/Dec time 3

3: Acc/Dec time 4

4: Acc/Dec time 5

5: Acc/Dec time 6

6: Acc/Dec time 7

4-2-10. Swing frequency function parameters (Group P9)

Swing frequency is widely used in textile and chemical fiber industry which need to horizontal move and winding. The typical application is shown in Fig. 4-45. The swing frequency process: accelerate to the preset frequency of swing frequency (P9.02), wait for a while (P9.03), decelerate to center frequency of swing frequency, cycle run according to the preset swing frequency width (P9.04), jump frequency (P9.05), swing frequency period (P9.06) and up time (P9.07) until the stop command is input.

The center frequency is the preset frequency of normal running, multi-speed running or PLC running.

Auto-cancel the swing frequency when jog or close-loop operation.

PLC runs with the swing frequency, the swing frequency will be invalid when PLC switches the stages. It enters the swing frequency after accelerating or decelerating to preset frequency according to the acc/dec setting of PLC stage. Stop according to the acc/dec time setting of PLC stage.

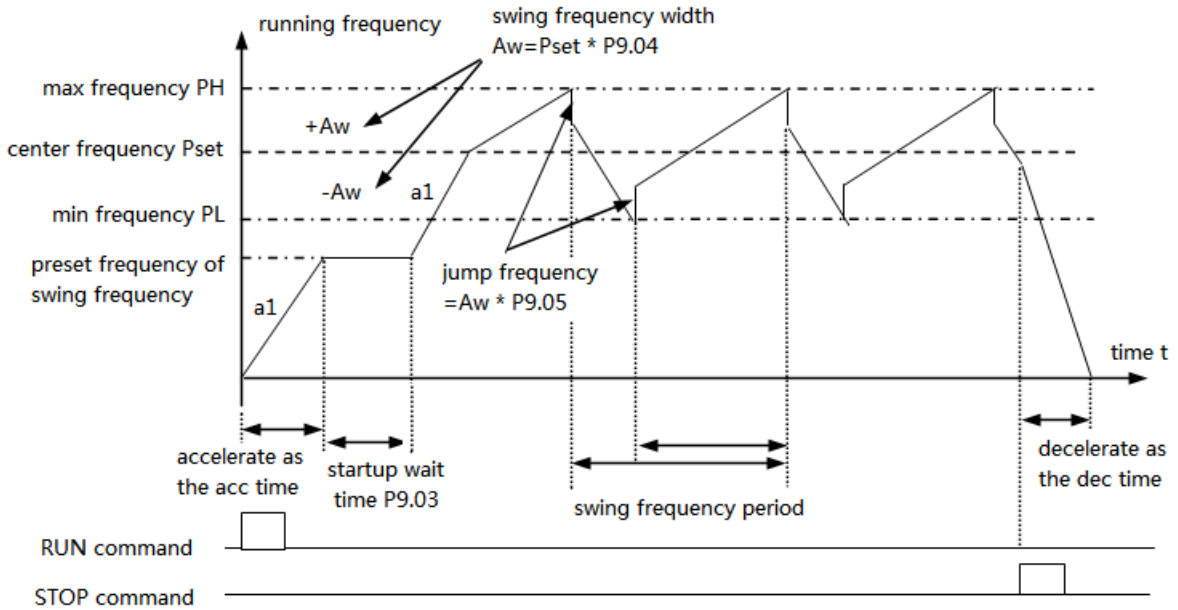

Fig.4—45 swing frequency

P9.00	Swing frequency function	Range: 0, 1	0
-------	--------------------------	-------------	---

0: Disabled

1: Enabled

P9.01	Swing frequency running mode	Range: 00~11	0
-------	------------------------------	--------------	---

Lowest bit of LED: input mode

0: Auto input mode. The inverter will run at preset frequency (P9.02) for a while (P9.03), and then enter the swing frequency status.

1: Terminal manual input mode. If the multi-function terminal (Xi is set to No.25 function) is enabled, the inverter will enter swing frequency status. If the terminal is disabled, the inverter will quit swing frequency and run at preset swing frequency (P9.02).

Ten bit of LED: swing frequency width

0: Variable width. Width AW changes with the center frequency and the changing rate is defined by P9.04.

1: Fixed width. Width AW is decided by max frequency and P9.04.

P9.02	Preset swing frequency	Range: 0.00~650.00Hz	0.00Hz
P9.03	Waiting time of preset swing frequency	Range: 0.0~6000.0s	0.0s

P9.02 is used to set running frequency before entering swing frequency.

If you select auto start mode, P9.03 is used to set the running lasting time at preset swing frequency before the inverter enter swing frequency; if you select manual start mode, P9.03 is disabled. Refer to Fig. 4-45.

P9.04	The width of swing frequency	Range: 0.0~50.0%	0.0%
-------	------------------------------	------------------	------

Variable width: $A_w = \text{Center frequency} \times P9.04$

Fixed width: $A_w = \text{Max running frequency } P0.06 \times P9.04$

Prompt: The swing frequency is limited by upper/lower frequency, it will work abnormal if set uncorrect.

P9.05	Jump frequency	Range: 0.0~50.0%	0.0%
-------	----------------	------------------	------

As shown in Fig4-45, there is no jump frequency if P9.05 = 0.

P9.06	Swing frequency period	Range: 0.1~999.9s	10.0s
-------	------------------------	-------------------	-------

It defines the complete period of swing frequency up/down process.

P9.07	Up time of triangle wave	Range: 0.0~98.0%	50.0%
-------	--------------------------	------------------	-------

Running time of swing frequency up stage = $P9.06 \times P9.07$ (s), Time of down stage = $P9.06 \times (1 - P9.07)$ (s). Refer to Fig.4—45.

Note: You can select S-curve Acc/Dec mode along with swing frequency, the swing frequency will run more smoothly.

P9.08	set length	Range: 0.000~65.535km	0.000(km)
P9.09	Actual length	Range: 0.000~65.535km	0.000(km)
P9.10	Times of length	Range: 0.001~30.000	1.000
P9.11	Calibration coefficient of length	Range: 0.001~1.000	1.000
P9.12	Perimeter of shaft	Range: 0.01~100.00(cm)	10.00(cm)
P9.13	pulses per revolution	Range: 1~9999	1

These parameters are used to realize fixed length control.

The counting pulses is input via terminal (X6, defined as function 35), and calculate the length according to the pulses per revolution (P9.13) and perimeter of shaft (P9.12).

Calculated length = counting pulses \div pulses per revolution \times perimeter of shaft

The length can be corrected through times of length (P9.10) and calibration coefficient of length (P9.11), and the length is the actual length.

Actual length = calculated length \times calibration coefficient of length \div calibration coefficient of length

When actual length (P9.09) \geq preset length (P9.08), the inverter will send out STOP command. When the inverter restarts, it needs to clear the actual length (P9.09) or make the actual length (P9.09) less than preset length (P9.08), otherwise the inverter will not start.

Note: (1) The actual length (terminal Xi is defined to function 36) can be cleared by multi-function input terminal. The actual length can be calculated only after this terminal is disconnected.

(2) Actual length (P9.09) will be saved after power off.

(3) The fixed length stop function is disabled if $P9.08 = 0$, but the calculated length is still effective.



4-2-11. Vector control parameters (Group PA)

PA.00	Motor auto-tune	Range: 0, 1	0
-------	-----------------	-------------	---

0: No tune

1: Tune when static

Operating process of auto-tune:

- (1) Set motor label parameter PA.01~PA.05
- (2) Set panel operation P0.03=0
- (3) Set PA.00=1, enter auto-tune
- (4) Press  , the screen will show RUN
- (5) Press  , start the auto-tune
- (6) After a while, the screen show PA which means the auto-tune is finished
- (7) Please check PA.09 (stator resistor) which is modified.

PA.01	Rated voltage of motor	Range: 0~400V	Model confirmation
PA.02	Rated current of motor	Range: 0.01~500.00A	Model confirmation
PA.03	Rated frequency of motor	Range: 1~99Hz	Model confirmation
PA.04	Rated speed of motor	Range: 1~9999 r/min	Model confirmation
PA.05	Polarity of motor	Range: 2~48	Model confirmation

PA.06	Stator inductance of motor	Range: 0.1~5000.0mH	Model confirmation
PA.07	Rotor inductance of motor	Range: 0.1~5000.0mH	Model confirmation
PA.08	Mutual inductance of motor rotor and stator	Range: 0.1~5000.0mH	Model confirmation
PA.09	Stator resistance of motor	Range: 0.001~50.000Ω	Model confirmation
PA.10	Rotor resistance of motor	Range: 0.001~50.000Ω	Model confirmation

PA.01~PA.10 are motor parameters which have default setting according to inverter model, you can reset these parameters according to the motor parameters. PA.01~PA.10 are used to vector control, which should be input correctly to realize the expecting effect.

PA.11	Over current protection coefficient of torque current	Range: 0~15	15
-------	---	-------------	----

In vector control, this parameter is used to control torque current to avoid over current, 0~15 correspond to 50% ~ 200%.

PA.12	Proportion adjustment coefficient of speed-loop	Range: 50~120	85
PA.13	Integral adjustment coefficient of speed-loop	Range: 100~500	360

In vector control, PA.12~PA.13 are used to control the motor speed. Adjust the two parameters can realize better effect for motor speed control.

PA.14	Vector torque boost	Range: 100~150	110
-------	---------------------	----------------	-----

In vector control, this parameter is used to boost the motor output torque. You can increase this parameter to boost motor output torque for large load.

PA.17	Excitation	Range: 100~150	120
-------	------------	----------------	-----

In vector control mode, this parameter is used to adjust the stator flux intensity. It can improve the vector torque output performance by setting this parameter. Please don't set it too large avoid flux supersaturated.

PA.18	Slip compensation coefficient	Range: 0%~150%	100%
-------	-------------------------------	----------------	------

In vector control mode, this parameter is used to adjust the slip frequency of vector control. It can improve the accuracy of speed control. It can suppress the speed static error.

4-2-12. Special application function parameters (Group PB)

PB.00	The source of jog frequency	Range: 0~4	0
-------	-----------------------------	------------	---

0: P3.06

1: Panel potentiometer

2: P0.02

3: VI

4: CI

PB.01	Dead zone time of forward/reverse running	Range: 0,1	0
-------	---	------------	---

0: Always valid. Based on the value set in P0.05, the minimum value is 0.1s.

1: The time can be set to 0 (no dead time) .You should set P0.05=0.0s, P0.20 \geq 0.5Hz.

This function is usually used to the continuous to-and-for control. If swift turn-around is needed, reduce the Acc/Dec time and increase the lower limit frequency/start frequency. (P0.17 \leq 0.5s, P0.18 \leq 0.5s, P0.20 \geq 2.0Hz, P2.01 \geq 2.0Hz) .

PB.02	Inverter type select	Range: 0, 1	0
-------	----------------------	-------------	---

0: G type (general type), fit for normal situation.

1: P type (fans, water pump), fit for fans, water pump and other small load situation. In this mode, power will improve 1 level, if the machine power is 2.2KW, in P type mode, the power will improve to 3.7KW. Please note P0.22 should be set to 3.

PB.03	Run mode	Range: 0,1	1
-------	----------	------------	---

0: before power on, if the terminal is short, run the inverter immediately.

1: before power on, if the terminal is short, run the inverter after cut off the terminal and connect it again.

4-2-13. Default setting and password (Group PF)



PF.00	Default password	—	—
-------	------------------	---	---

PF.01	User password	Range: 0000~9999	0000
-------	---------------	------------------	------

This parameter can prohibit the unauthorized personnel from viewing or modifying function parameters.

Please set it to 0000 if don't need user password.

If use password is needed, input four figures as password, then press  to confirm, the password will be valid immediately.

Modification: Press  key to validate password, input correct password to enter parameter editing status. Choose PF.01 (PF.01=0000), input new password and press  to confirm, then the password will be valid immediately. The password for super user is 2644.

PF.02	Software version	—	—
-------	------------------	---	---

Software version is set by Xinje company, cannot be changed.



5 Fault Diagnosis and solution

5-1. Fault diagnosis and solution

When fault occurs, the error code will show in LED display, the inverter stops outputting and the fault relay contactor is activated. If the motor is running when the fault occurs, motor will free stop. Table 5-1 is the fault inverter may happen. Please check the fault according to the table or contact us for service.

Table 5-1 Fault and solution

Fault Code	Fault Type	Possible reason	Solution
E-01	Over-current when accelerating	Too heavy the load and too short the Acc time	Increase the acceleration time
		V/F curve is not suitable	Adjust V/F curve setting
		Restart the motor when it is running	Set to restart after speed detection
		torque boost value is too large	Adjust the value of manual torque boost or change to auto torque boost
		Inverter power is too low	Select higher power inverter
E-02	Over-current when decelerating	Too short Dec time	Increase the Dec time
		Potential or big inertia load	Increase the brake power of external brake unit
		Inverter power is too low	Select higher power inverter
E-03	Over-current when constant speed running	Sudden change of load	Check and reduce the change of load
		Too short Acc/Dec time	Increase the Acc/Dec time
		Abnormal load	Check the load
		AC supply voltage is low	Check AC supply voltage
		Inverter power is too low	Select higher power inverter
E-04	Over-voltage when accelerating	Abnormal input voltage	Check input power supply
		Too short Acc time	Increase the Acc time
		The rotating motor restarts after stop	Set to restart after speed detection
E-05	Over-voltage when decelerating	Too short Dec time	Increase Dec time
		Potential or big inertia load	Increase the brake power of external brake unit
E-06	Over-voltage when constant speed running	Abnormal input voltage	Check input power supply
		Too short Acc/Dec time	Increase the Acc/Dec time
		Abnormal change of input voltage	Install input reactor
		Too big the load inertia	Connect suitable braking unit
E-07	Inverter power supply over-voltage	Abnormal input voltage	Check input power or ask for service
E-08	Inverter overheat	Duct blockage	Clean the duct and improve ventilation condition
		Ambient temperature too high	Improve ventilation condition and decrease carrier frequency
		Fan is broken	Change the fan
		IGBT module is abnormal	Ask for help
E-09	Inverter overload	Too short Acc time	Increase the Acc time
		DC braking current is too big	Reduce DC braking current and increase braking time

		V/F curve is not suitable	Adjust V/F curve and torque boost value
		Restart the motor when it is running	Set to restart after speed detection
		Low AC supply voltage	Check AC supply voltage
		Too heavy load	Select higher power inverter
E-10	Motor overload	V/F curve is not suitable	Adjust V/F curve and torque boost value
		Low AC supply voltage	Check AC supply voltage
		Common motor is running with heavy load at low speed for a long time	Please choose frequency conversion motor
		Unsuitable motor overload protection coefficient	Set motor overload protection coefficient correctly
		The motor is blocked or the load change too much	Check load
E-11	Under-voltage when running	Too low AC supply voltage	Check AC supply voltage
E-12	Inverter module protection	Instant over current of inverter	Refer to solution of over current
		3-phase output is short together or ground short	Rewiring
		Duct is blocked or fan is damaged	Clean the duct or change the fan
		Ambient temperature is too high	Reduce environment temperature
		Wires or connectors of control board are loose	Check and rewiring
		Current waveform distorted due to output phase loss	Check wiring
		Auxiliary power is damaged and inverter voltage is low	Ask factory or agent for service
		Abnormal control board	Ask factory or agent for service
E-13	Peripheral equipment fault	Emergency stop terminal of peripheral equipment is close	Solve the external fault and cut off the terminal
E-14	Current detection circuit is error	Wires or connectors of control board are loose	Check and rewiring
		Auxiliary power supply is damaged	Ask factory or agent for service
		Hall part is damaged	Ask factory or agent for service
		Amplifying circuit is abnormal	Ask factory or agent for service
E-15	RS485 Communication error	Baud rate is not suitable	Set suitable baud rate
		Serial port communication error	Press  key to reset, or ask for service
		Unsuitable alarm parameter	Modify the setting of P3.09~P3.12
		Host PC does not work	Check host PC, check the wiring
E-16	System interference	Serious interference	Press  key to reset or install power filter at the input side of the inverter
		W/R error of DSP in main control board	Press keys to reset, ask for service
E-17	E ² PROM W/R error	W/R error of control parameter	Press  key to reset or ask for service
E-18	DC brake overcurrent	Set wrong current of DC brake	Decrease the percentage of brake current

E-24 POFF	Main circuit under voltage, the electromagnetic contactor action error	Lack of phase when input current, momentary power off, power supply terminals are loose, power supply voltage fluctuates serious, the main circuit contactor is open	Check the reason and reset Check the power supply Ask the factory or agent for help
E-30/31	Lack of phase when inverter running or stop	Input power supply lack of phase, momentary power off, power supply terminals are loose, power supply voltage fluctuates serious, the voltage between phases is unbalance	Check the reason then reset
EEEE	Operate panel communication error	Operate panel and CPU board connection is not good, the control circuit of inverter is not good	Uninstall the operate panel and install again, ask the factory for help

5-2. Check the fault records

The inverter records the last 6 times fault code and the running parameter of last fault. Checking these information can help to solve the problem. The fault records are stored in P6.

5-3. Fault reset

Once the fault occurs, select one of the following operations to restart the inverter:

- (1) When fault code displayed in the operation panel, press  key after you confirm the inverter can be reset.
- (2) After setting one terminal among X1~X8 as external RESET input (P4.00~P4.07=17), connect it with COM terminal and then disconnect.
- (3) Cut off the power supply



Note:

- (1) Please make sure you know the reason of the fault and get rid of it before resetting, otherwise the inverter may be damaged permanently.
- (2) If the inverter can not be reset or fault reoccurred after resetting, please check the reason as the inverter may be damaged by resetting continuously.
- (3) Delay 5 minutes to reset when overload and overheat protection are enabled.

6 Maintenance

6-1. Maintenance

Environment effects such as ambient temperature, humidity, fog, internal component aging and other factors will give rise to the occurrence of potential faults. Therefore, it is necessary to daily check and routine maintain the inverters.

6-1-1. Routine maintenance

Please confirm the following items when start the inverter.

- (1) If there is abnormal noise and vibration with the motor.
- (2) If the inverter and motor heat unusually.
- (3) If the environment temperature is too high.
- (4) If the value of load amperometer is as usual.
- (5) If the fan of inverter can operate normally.

6-2. Periodical care and maintenance

6-2-1. Periodical care

Before checking and maintaining the inverter, please make sure that the inverter is power off, monitor has no display content and the indication lamp of main circuit power is off. The checking contents are shown in Tabel 6-1.

Table 6-1 periodical maintenance

Items	Contents	Countermeasures
The screw of main circuit terminals, control circuit terminals	If the screws are loose	Tighten the screws with screw drivers
Heatsink	If there is dust	Use dry compressed air with 4~6kgcm ² pressure
PCB board	If there is dust	Use dry compressed air with 4~6kgcm ² pressure
Cooling fan	There is abnormal noise, vibration, or if it has run for more than 20 000 hours.	Change cooling fan
Power component	If there is dust	Use dry compressed air with 4~6kgcm ² pressure
Aluminium electrolytic capacitor	If it has changed color, particular smell or bubble	Change aluminium electrolytic capacitor

6-2-2. Periodical maintenance

To make the inverter work normally for long time, periodical care and maintenance for inverter's internal electronic component should be done. The electronic component's lifetime depends largely on their application environment and preservation. The reference lifetime are shown in table 6-2:

Table 6-2 Lifetime of inverter components

Component	Life
Cooling fan	2~3 year
Electrolytic capacitors	4~5 year
Print circuit board	5~8 year
Fuse	10 year

The usage conditions of the above components are shown below:

- (1) Environmental temperature: 30°C in average.
- (2) Load coefficient: less than 80%.
- (3) Running time : less than 12 hours per day.

6-3. Warranty of the inverter

Xinje Company will offer warranty service in the case of the following situations:

- (1) The warranty range only points to the inverter;
- (2) We will take the responsibility of 15 months defects liability period for any faults or damages under the normal operation conditions. After 15 months, maintenance will be charged;
- (3) Even within 15 months, maintenance would be charged under the following conditions:
 Inverter is damaged due to incorrect operation, which are not in compliance with “User Manual”;
 Inverter is damaged due to fire, flood, and abnormal voltage and so on;
 Inverter is damaged due to wiring fault.
 Inverter is damaged due to the improper use of drive functions;
- (4) Service fee will be charged according to the actual costs. If there are any maintenance contracts, the contract has priority.

7 Communication Protocol

7-1. Overview of communication protocol

The inverters supply RS485 communication port and adopt MODBUS started communication protocol. Therefore, the inverter can be set as a slave to communicate with the master (such as PLC and PC) which has the same communication port and protocol; also, user can use a inverter as the master to communicate with several inverters produced by our company via RS485 port to realize multi-machine linkage. Besides, you can connect the RS485 port to remote keyboard to realize remote operation. This inverter support MODBUS-RTU, the following is the particular instruction for the inverter's communication protocol.

7-2. Communication protocol

7-2-1. Communication networking mode

Inverter as a slave

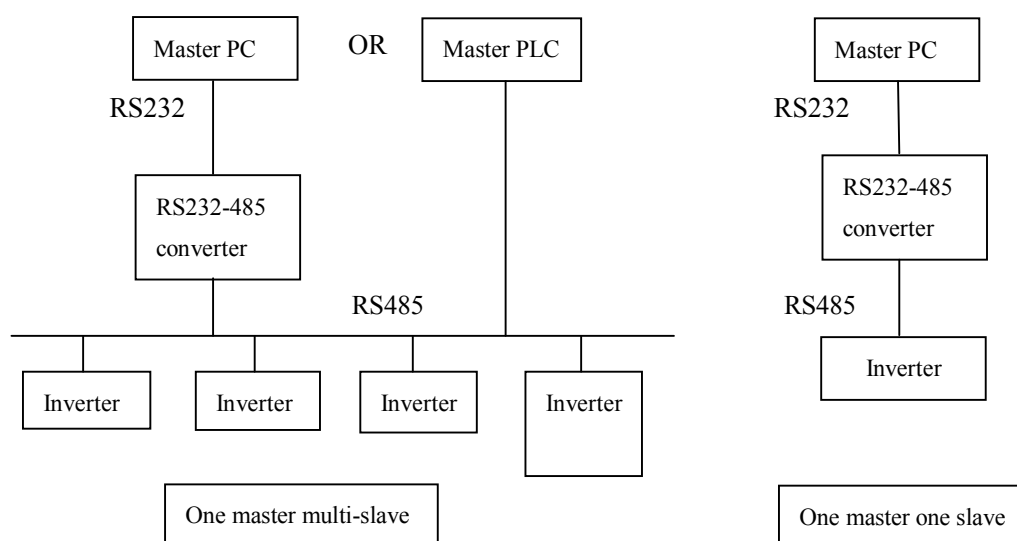

Fig.7-1 Networking diagram of inverter

Multi-device linkage

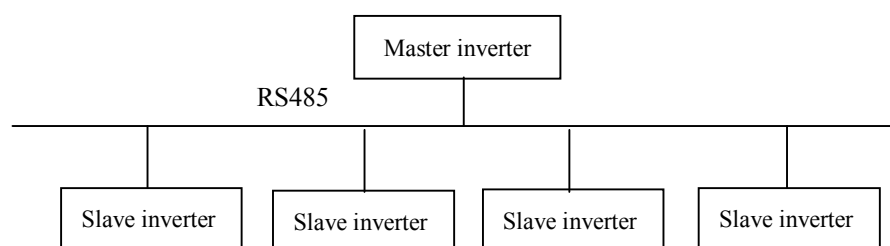

Fig 7-2 Networking diagram of multi-device linkage

7-2-2. Communication protocol modes

The inverter can be master and slave in RS485 network. If it is master, it can control other inverters made by our company to realize multi-machine linkage. If it is slave, PC or PLC (master) can control it. The concrete communication modes are shown below:

- (1) The inverter is slave, master-slave point-to-point mode. The slave devices will not response when master sends requires by broadcast address.
- (2) The inverter is master. The slave devices will not response when master sends requires by broadcast address.
- (3) Users can set the inverter address, baud rate and data format via the keypad or serial port.
- (4) The slave reports the current fault information in the latest response frame.

7-2-3. Communication port

RS485 port is asynchronous serial, half-duplex transmission. Default data format: 1 start bit, 8 data bits, 1 stop bit.

Default baud rate 19200bps, the communication parameters please refer to P3.09~P3.12.

7-3. Modbus-RTU communication protocol

7-3-1. Character structure

(1-8-2 format, None)

Start bit	0	1	2	3	4	5	6	7	Stop bit	Stop bit
-----------	---	---	---	---	---	---	---	---	----------	----------

(1-8-1 format, Odd)

Start bit	0	1	2	3	4	5	6	7	Odd	Stop bit
-----------	---	---	---	---	---	---	---	---	-----	----------

(1-8-1 format, Even)

Start bit	0	1	2	3	4	5	6	7	Even	Stop bit
-----------	---	---	---	---	---	---	---	---	------	----------

(1-8-1 format, None)

Start bit	0	1	2	3	4	5	6	7	Stop bit
-----------	---	---	---	---	---	---	---	---	----------

7-3-2. Communication information

1. RTU mode:

START	Keep no signal input $\geq 10\text{ms}$
Address	Communication address: 8-bit binary address
Function	Function code: 8-bit binary address
DATA (n - 1)	Data: N*8-bit data, $N \leq 8$, Max=8 bit
.....	
DATA 0	
CRC CHK Low	CRC parity code
CRC CHK High	16-bit CRC parity code is combined by 2 8-bit binary value
END	Keep no signal I/O $\geq 10\text{ms}$

2. Communication address:

00H: broadcast for all the inverters (broadcast)
 01H: communicate with the inverter addressed 01
 0FH: communicate with the inverter addressed 15
 10H: communicate with the inverter addressed 16
, max can reach 254 (FEH)

3. Function code and Data:

Function code	Explanation
03H	Read register, read multi-register once (register less than 31), can read the same group of data every time
06H	Write data to register
08H	Circuit test
10H	Write multi-group data to register

(1) Function code 03H: read register

For example: Read address 2104H (Output current)

RTU Mode:

Request mode		Response mode	
Address	01H	Address	01H
Function code	03H	Function code	03H
Register address	21H	Byte No.	02H
	04H		
Register No.	00H	Dada	00H
	01H		00H
CRC CHECK Low	CFH	CRC CHECK Low	B8H
CRC CHECK High	F7H	CRC CHECK High	44H

(2) Function code 06H: Write to register

For example: 01H, write function code P0.02=50.00HZ.

RTU Mode:

Request mode		Response mode	
Address	01H	Address	01H
Function code	06H	Function code	06H
Register address	00H	Register address	00H

	02H		02H
Data	13H	Data	13H
	88H		88H
CRC CHECK Low	25H	CRC CHECK Low	25H
CRC CHECK High	5CH	CRC CHECK High	5CH

(3) Command mode: 08H circuit test

This command is used to test if the communication between the device (master) and inverter (slave) is normal. Inverter will send the data to control device.

RTU mode:

Request mode		Response mode	
Address	01H	Address	01H
Function code	08H	Function code	08H
Data	01H	Data	01H
	02H		02H
	03H		03H
	04H		04H
CRC CHECK Low	41H	CRC CHECK Low	41H
CRC CHECK High	04H	CRC CHECK High	04H

(4) Function code 10H: write multi-group data to the register

Note: V5/VB5 inverters only support one pack of data write in.

For example: write P0.06=50.00Hz in inverter address 01H.

RTU mode:

Inquiry information format		Reply information format	
address	01H	address	01H
Function code	10H	Function code	10H
Register address	00H	Register address	00H
	06H		06H
Register quantity	00H	Register quantity	00H
	01H		01H
Byte quantity	02H		
Data	13H		
	88H		
CRC CHECK Low	ABH	CRC CHECK Low	E1H
CRC CHECK High	60H	CRC CHECK High	C8H

5. Parity code

RTU mode: Double bytes hex number

CRC field has two bytes 16-bit binary number. It is added to the message after calculating by sending terminal. The low byte is added at first, and then is the high byte. CRC high byte is the last byte to be

sent. The receiving device will calculate the CRC again and compare to the received CRC value. If the two value are not the same, discard this frame and receive the next frame.

7-3-3.Communication parameter

Name	Parameter address	Function
Internal parameters setting	GGnnH	GG stands for parameter group, nn stands for parameter No.
Command for inverter (06H)	2000H	0001H: Running command (Forward)
		0002H: Forward command
		0003H: Reverse command
		0004H: Jog command (Forward)
		0005H: Jog forward command
		0006H: Jog reverse command
		0007H: Decelerate stop command
		0008H: Emergency stop command
		0009H: Jog stop command
		000AH: Fault reset command
	2001H	Set frequency via serial port
Monitor inverter status (03H)	2100H	Read inverter fault code
	2101H	Read inverter status
		BIT0: stop sign, 0: Stop; 1: Run
		BIT1: 1: under voltage; 0: normal
		BIT2: forward/reverse sign, 1: forward; 0: reverse
		BIT3: jog sign 1: jog; 0: not jog
		BIT4: close loop control selection, 1: close loop; 0: not close loop
		BIT5: swing frequency sign, 1: swing frequency; 0: no swing frequency
		BIT6: PLC running flag, 1: PLC running; 0: no
		BIT7: Multi-speed running flag of terminals, 1: Multi-speed; 0: no
		BIT8: Common running flag, 1: common running; 0: no
		BIT9: Main frequency from communication interface, 1: yes; 0: no
		BIT10: Main frequency from analog input, 1: yes; 0: no
BIT11: Running command from communication interface, 1: yes; 0: no		
BIT12: Password protection for parameters, 1: yes; 0: no		
	2102H	Read inverter setting frequency
	2103H	Read inverter output frequency
	2104H	Read inverter output current
	2105H	Read inverter bus voltage
	2106H	Read inverter output voltage
	2107H	Read motor speed
	2108H	Read module temperature
	2109H	Read VI analog input
	210AH	Read CI analog input
	210BH	Read inverter software version
	210CH	I/O terminal status
		Bit0: X1
		Bit1: X2
		Bit2: X3

		Bit3: X4
		Bit4: X5
		Bit5: X6
		Bit6: FWD
		Bit7: REV
		Bit8: OC
		Bit9: relay output
Read data of function code (03H)	GGnnH (GG: Group No. of function code nn: function code No.)	Inverter responses to the data (When use Modbus address, the nn must be turned into hex)
Write data to function code (06H)	GGnnH (GG: Group No. of function code nn: No. of function code)	Write inverter data of function code (When use Modbus address, the nn must be turned into hex)

Example:

Read function code P1.02:

01H, 03H, 01H, 02H, 00H, 01H, CRC1, CRC2

Read inverter setting frequency:

01H, 03H, 21H, 02H, 00H, 01H, CRC1, CRC2

Write function code P1.02, the write value is 1

01H, 06H, 01H, 02H, 00H, 01H, CRC1, CRC2

Running command:

01H, 06H, 20H, 00H, 00H, 01H, CRC1, CRC2

Definition of fault code:

Fault code	Explanation
01H	Fault function code. Inverter can identify the function code: 03H, 06H, 08H
02H	Error data address. Inverter cannot identify the data address
03H	Error data. data over the limit

Note: The parameter address must in hex format, as the function codes of parameters are in decimal; you have to transform them into hex. For example, the Modbus address of function code P2.11 is 020BH.

Appendix A Accessories

A-1. Brake resistor

1.5~18.5KW (not including VB5-21P5, VB5-22P2) inverters have built-in brake unit. Please select brake unit as table 1-1. 22KW and above inverters need to connect brake unit. Please refer to Fig. 1-1 for wiring.

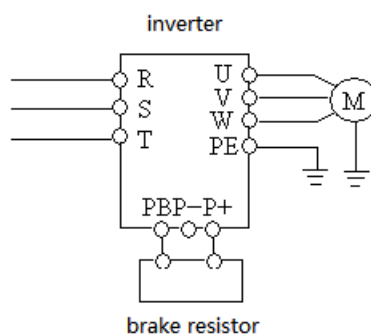

Figure 1-1 Wiring of inverter and brake units

The brake unit wiring of inverter:

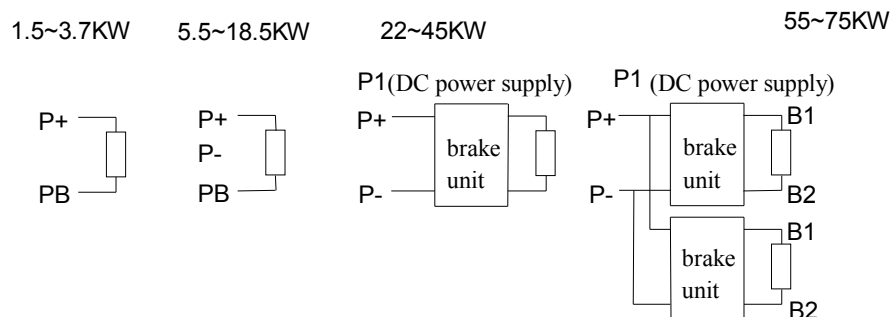

Table 1-1 Braking resistor selection

Spec. (KW)	Brake unit		Brake resistor		
	Spec	Quantity	Equivalent brake resistor (Ω)	Equivalent brake power (W)	
380V	1.5	Built-in	1	300	400
	2.2		1	200	500
	3.7		1	200	500
	5.5		1	100	500
	7.5		1	75	1000
	11		1	50	1000
	15		1	40	1500
	18.5		1	32	5000
	22	External	1	27.2	5000
	30		1	20	6000
	37		1	16	9600
	45		1	13.6	9600
	55		1	10	12000

A-2. Operate panel

Operate panel	Power (KW)	Suitable model	Mounting dimension W*H (mm)
V5-OPU-01	0.75~2.2	VB5 series single-phase	62*75
	0.75~3.7	VB3, VB5 series 3-phase	
	5.5~7.5	VB5 series 3-phase	
V5-OPU-03	11~55	V5 series	71*131

A-3. Extension cable of operate panel

The frequency inverter will be attached with 0.3m extension cable when out of factory. Besides, we also provide 0.5m, 1.0m, and 1.5m extension cables.

Cable type	Length (m)
V5-ECC-05	0.5
V5-ECC-10	1.0
V5-ECC-15	1.5

Appendix B Function configuration list

The terminal and function of inverter is shown in table 1~3:

Note: ○ user selection × not support √ support

Table 1:

Voltage level	Type	Power (KW)	Current (A)	Vector	RS485	Brake unit	Brake resistor
220V/ 1-phase	VB3-20P7	0.75	4.7	×	√	No	×
	VB5-20P7	0.75	4.7	×	√	Built-in	150Ω/200W○
	VB5-21P5	1.5	7.5	×	√	Built-in	100Ω/400W○
	VB5-22P2	2.2	10	×	√	Built-in	70Ω/500W○
380V/ 3-phase							
	VB3-40P7	0.75	2.5	√	√	No	×
	VB3-41P5	1.5	4.7	√	√	No	×
	VB3-42P2	2.2	6	√	√	No	×
	VB3-43P7	3.7	9.6	√	√	No	×
	VB5-40P7	0.75	2.5	√	√	Built-in	750Ω/100W○
	VB5-41P5	1.5	4.7	√	√	Built-in	300Ω/400W○
	VB5-42P2	2.2	6	√	√	Built-in	200Ω/500W○
	VB5-43P7	3.7	9.6	√	√	Built-in	200Ω/500W○
	VB5-45P5	5.5	14	√	√	Built-in	100Ω/500W○
	VB5-47P5	7.5	17	√	√	Built-in	75Ω/1000W○
	V5-4011	11	25	√	√	Built-in	50Ω/1000W○
	V5-4015	15	33	√	√	Built-in	40Ω/1500W○
	V5-4018	18.5	38	√	√	Built-in	32Ω/5000W○
	V5-4022	22	46	√	√	External (note1)	27.2Ω/5000W○
	V5-4030	30	60	√	√	External (note1)	20Ω/6000W○
V5-4037	37	75	√	√	External (note1)	16Ω/9600W○	
V5-4045	45	90	√	√	External (note1)	13.6Ω/9600W○	
V5-4055	55	110	√	√	External (note1)	10Ω/12000W○	

Note1: the external brake unit can select from other company, such as BRU-4045.

Table 2:

Voltage level	Type	Multi-funtion input	Pulse input X6	Relay output	Transistor output OC
220V/ 1-phase	VB3-20P7	X1~X3	×	√	×
	VB5-20P7	X1~X3	×	√	×
	VB5-21P5	X1~X3	×	√	×
	VB5-22P2	X1~X3	×	√	×
380V/ 3-phase	VB3-40P7	X1~X4	×	√	√
	VB3-41P5	X1~X4	×	√	√
	VB3-42P2	X1~X4	×	√	√
	VB3-43P7	X1~X4	×	√	√
	VB5-40P7	X1~X4,X6	√	√	√
	VB5-41P5	X1~X4,X6	√	√	√
	VB5-42P2	X1~X4,X6	√	√	√
	VB5-43P7	X1~X4,X6	√	√	√
	VB5-45P5	X1~X6	√	√	√
	VB5-47P5	X1~X6	√	√	√
	V5-4011	X1~X6	√	√	√
	V5-4015	X1~X6	√	√	√
	V5-4018	X1~X6	√	√	√
	V5-4022	X1~X6	√	√	√
	V5-4030	X1~X6	√	√	√
	V5-4037	X1~X6	√	√	√
	V5-4045	X1~X6	√	√	√
	V5-4055	X1~X6	√	√	√

Table 3:

Voltage level	Type	Pulse output DO	Analog input VI	Analog input CI	Analog output AO	External power supply	
		(compatible digital)	(0~10V)	(0~10V/4~20mA)	(0~10V/4~20mA)	24V	10V
220V/ 1-phase	VB3-20P7	×	×	√	×	×	√
	VB5-20P7	×	×	√	×	×	√
	VB5-21P5	×	×	√	×	×	√
	VB5-22P2	×	×	√	×	×	√
380V/ 3-phase							
	VB3-40P7	×	×	√	√	√	√
	VB3-41P5	×	×	√	√	√	√
	VB3-42P2	×	×	√	√	√	√
	VB3-43P7	×	×	√	√	√	√
	VB5-40P7	×	×	√	√	√	√
	VB5-41P5	×	×	√	√	√	√
	VB5-42P2	×	×	√	√	√	√
	VB5-43P7	×	×	√	√	√	√
	VB5-45P5	√	√	√	√	√	√
	VB5-47P5	√	√	√	√	√	√
	V5-4011	√	√	√	√	√	√
	V5-4015	√	√	√	√	√	√
	V5-4018	√	√	√	√	√	√
V5-4022	√	√	√	√	√	√	
V5-4030	√	√	√	√	√	√	
V5-4037	√	√	√	√	√	√	
V5-4045	√	√	√	√	√	√	
V5-4055	√	√	√	√	√	√	

